

FREE @ WWW.THEGADABOUT.COM TAKE ONE IT'S FREE

APRIL 2016

THE

GAD-A-BOUT™

ARCHERY, CAMPING, FISHING, HUNTING, HORSES, HUMOR, MILITARY TRAPPING, TRAVEL, EVENTS, OPINIONS, ETC.

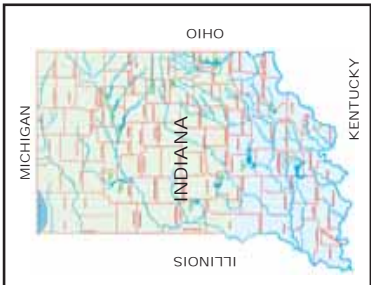

MOTHER EARTH HAS HAD CLIMATE CHANGE SINCE ITS BEGINNING TO BE ABLE TO MOVE WEIGHT SECOND BY SECOND - SEE PAGE 10



A SPRING MOREL TRYING TO HIDE IN THE GROUND CLUTTER PAGES 8 & 9



WEBSTER PIRATES, THE BASKETBALL BASH WINNING TEAM - SPECIAL 4 PAGE 15-18 PULL OUT ADVERTISER INDEX PG 2 / ARTICLE INDEX PG 3 READ ABOUT COVER PHOTOS ON PAGE 3

TO ADVERTISE IN THE GAD-A-BOUT SEE RATES ON PAGE 31 • CELL 1-765-960-5767 • WEBSITE: www.thegadabout.com • E-MAIL: raythegadabout@gmail.com

NOBLE BOYS FURNITURE



Featuring Solid Oak and Solid Wood Bedrooms, Dining Rooms, Living Rooms and Other Household Items Dutch Craft Bedding Made by Amish



6032 Holland Rd., Brookville, IN (White's Farm - U.S. 52)
Hours: Mon-Fri 9:00 am - 5:00 pm / Sat 9:00 am - 4:00 pm

CALL: 765-647-4875

"Quality Furniture At Fair Prices"

3 Miles South of Brookville See Map

Save 10 - 50% Off Selected Items

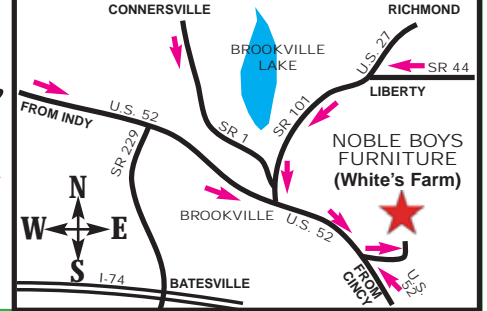

ADVERTISER INDEX

YOU CAN PICK UP A FREE COPY OF THE GAD-A-BOUT AT THE ADVERTISERS LISTED BELOW or READ IT FOR FREE AT www.thegadabout.com

INDIANA
ANDERSON
 9 Guns Pg 12
AUSTIN
 Burris Electric & Plumbing Pg 13
BATESVILLE
 French's Locker LLC Pg 24
BROOKVILLE
 52 Pik-up Convenience Store Pg 5
 Brookville Lake Guide Service Pg 7
 Dairy Cottage Pg 9
 Noble Boys Furniture Pg 1
 Pioneer Restaurant Pg 5
BROOKVILLE LAKE AREA
 Barton Bay Pg 8
 Dave's Triangle Pg 4
 Frames Outdoor Pg 11
 Parkside Marine & More Pg 3
 Steve's Marine Pg 11 & 29
BUTLERVILLE
 Butlerville Grocery Pg 13
CAMPBELLSBURG
 Campbellsburg Hardware Pg
 Worley Farm Salvage Pg 19
CAMBRIDGE CITY
 A - T & I Service Pg 16
CEDAR GROVE
 Grasshopper The Grasshopper Pg 4
CENTERVILLE
 Animal Hospital of Centerville Pg 23
 Mills Funeral Home Pg 17
 Vintage Karting Specialty Pg 7
CONNERSVILLE
 Fayette County Tourism Pg 14
 Matt's Custom Guns Pg 18
 Wells Variety Store Pg 29
DEPUTY
 Marion's Greenhouse Pg 22
DUBLIN

Rihm's Meat Processing Pg 2
DUNLAPSVILLE
 Smokin' on the Water BBQ Fest Pg 29
GREENFIELD
 Highsmith Guns Pg 12
 J & M Sporting Goods Pg 10
 Jensen's Pawn & Guns Pg 17
GREENSBURG
 Country Mart/Prem1ier Ag Pg 20
 Guns & Tackle, Inc. Pg 5
 Tree City Metal Sales Pg 25
HANOVER
 Pate Meat Processing Pg 26
HARDY LAKE
 Pioneer Village Pg 19
INDIANAPOLIS
 Indiana State Police Pg 6
 www.IndianaOutfitters.com Pg 31
KNIGHTSTOWN
 Knightstown Meats & Catering Pg 4
 McDonald's Bait & Tackle Pg 10
 RW Gunsmith Shop Pg 7
KOKOMO
 Joe's Beef Jerky Pg 20
 Kokomo Marine Pg 21
 Martino's Italian Villa Pg 20
LAKE MICHIGAN AREA
 Brother Nature Charters Pg 11
LAUREL
 Laurel Hotel Restaurant Pg 28
LEXINGTON
 Ernie's Traps & More Pg 23
LIBERTY
 Bertch Hardware Pg 14
 Carl Sharp State Farm Pg 24
 Liberty Restaurant Pg 21
 Woodruff's Supermarket Pg 18
LOGANSPOUT
 Dale Hardy Supplies Pg 23

MADISON
 B&R Roofing & Gen'l Contractor Pg 7
 Barry Phillips Electric LLC Pg 2
 Burris Elect & Plumbing Pg 13
MARION
 Riverside Sporting Gds Pg 10
MCCORDSVILLE
 Cap'n Hooks Bait & Tackle Pg 14
MILROY
 Milroy Shoes Pg 10
 Troyers Country Store & Bakery Pg 25
MUNCIE
 Lighthouse Bait & Tackle Pg 30
NOBLESVILLE
 Log Home Center Pg 22
 Sole Scraper Pg 13
NORTH VERNON
 Ebbing Auto Parts Pg 27
 John's Gun & Tackle Pg 7
PORTLAND
 1 Shot Sports Pg 4
PRAIRIE CREEK RESERVOIR
 Dry Dock Marina Pg 10
RICHMOND
 Army Navy Store Pg 21
 Best Pawn Pg 16
 Best Stop Auto Care Pg 21
 Cabinet Factories Outlet Pg 16
 Davis Transmissions Pg 4
 JoAnn's Cafe Pg 27
 Knuckle Busters Auto Repair Pg 4
 Larry Fouche for Commissioner Pg 15
 Mendenhall Hardware Pg 7
 Merkamp Sales & Service Pg 3
 Mighty Muffler Pg 28
 Prairie Wolf Gun Repair Pg 12
 Richmond's Complete Home Imprmt Pg 21
 Riggle-Waltermann Mortuary Pg 25
 Rogan Equipment Polaris Pg 9

Tri County Awards Pg 15
 Westside Storage Pg 15
 Wildfire Motors Pg 17
RIDGEVILLE
 Heritage Goodhew Metal Roofg Pg 27
RUSHVILLE
 Fields' Outdoor Adventures Pg 32
SALEM
 Red Barn Bait Shop Pg 30
SALAMONIES LAKE AREA
 Bozarth Country Store Pg 8
 S & S Bait & Tackle Pg 2
SCOTTSBURG
 C & T Cycles Pg 13
 Rick & Jeff's Floor Coverings Pg 10
 Scotts Ace Hardware Pg 19
SELMA
 Lighthouse Bait & Tackle Pg 30
SEYMOUR
 Burris Elect & Plumbing Pg 13
SHELBYVILLE
 Blue River Arms, LLC Pg 26
 The Gun Den Pg 26
STRAUGHN
 InLaws Archery & Pro Shop Pg 24
SUMMIT LAKE AREA
 Gittin Jiggy With It B&T Pg 22
UNDERWOOD
 Underwood Auto Parts Pg 23
VALLONIA
 Tollivers Hunting Fishing Supls Pg 28
WABASH
 Halderman Real Estate Pg 6
WILLIAMSBURG
 Rustic Acres Wood Works Pg 14
WEBSTER
 C & C Webster General Store Pg 4
OHIO
MARBLEHEAD - Lake Erie
 Boytim Charter Service "Walleye" Pg 5



Rihm Foods
 CAMBRIDGE CITY INDIANA 47327
CUSTOM HOG & BEEF PROCESSING
 "Venison Sausage and Hams"
 Custom Curing
 Hickory Smoked Hams & Bacons
CATERING
 (765) 478-3426 1-800-846-6328
www.rihmfoods.com



S&S Bait + Tackle
 (Salamonie Reservoir)
 • Bait • Tackle • Soft Drinks • Ice
 • Snacks • Picnic Supplies • Firewood
 • LP • Camping & Outdoor Equipment
 • Honey Bee Products • More
 Owner: Steve Chenoweth
 Monday to Saturday 6:00 a.m. -10:00 p.m. Sunday 7:00 a.m. to 7:00 p.m.
 8975 W. 600 S (Jct. Hwy 105 & 124) Andrews, IN 46702 / Ph: 260-468-2551
 Website: www.sandsbaitandtackle.com

SS Chenoweth
LED Emergency Vehicle Lighting
 Fenix - Inovation At It's Brightest
 Police • Fire • Emergency • Oversize Load
 Farm • Construction • Highway



Owner: Steve Chenoweth
 Monday to Saturday 6:00 a.m. -10:00 p.m. Sunday 7:00 a.m. to 7:00 p.m.
 8975 W. 600 S (Jct. Hwy 105 & 124) Andrews, IN 46702 / Ph: 260-468-2551
 Website: www.sandsbaitandtackle.com

THE GAD-A-BOUT SUBSCRIPTION FORM

THE GAD-A-BOUT IS FREE AT ADVERTISER LOCATIONS AND A FEW OTHER LOCATIONS DISTRIBUTED BY GAD-A-BOUT REPRESENTATIVES IF YOU WOULD LIKE TO HAVE THE GAD-A-BOUT DELIVERED TO YOU VIA THE U.S. POST OFFICE ON A MONTHLY BASIS YOU MAY SUBSCRIBE TO IT FOR ONE YEAR @ \$28.00 ANNUALLY

SEND A CHECK OR MONEY ORDER PAYABLE TO THE GAD-A-BOUT
 SEND TO: THE GAD-A-BOUT, 403 E. SCHOOL ST., CENTERVILLE, IN 47330-1528

NAME: _____
ADDRESS: _____
CITY, STATE: _____
ZIP CODE: _____

PLEASE NOTE: THE GAD-A-BOUT WILL BE MAILED TO YOU BY FIRST CLASS MAIL IN A 9" X 12" WHITE ENVELOPE. SEND ANY CHANGES OF YOUR ADDRESS TO THE ABOVE ADDRESS TO MAKE SURE YOU RECEIVE YOUR COPY ON TIME.

BARRY PHILLIPS ELECTRIC, LLC

"We Appreciate Your Business"



24-Hour Emergency Service

Master Licensed In Kentucky & Indiana Since 1981
 Service Calls • New Construction
 Service Upgrades • Electrical Repairs
 Bucket Truck Service Available
 Remodeling • Maintenance Repairs

Specializing In Historical Homes Madison's Expert Electrical Team

BONDED • INSURED
 RESIDENTIAL & COMMERCIAL WIRING



812-866-5749 • 877-966-5749 • CELL: 812-599-4657



THE GAD-A-BOUT™



IN THIS ISSUE

APRIL 2016 • Volume XXV • NO. 311

Created in 1990 & Published Monthly by Kentucky Colonel Ray Dickerson or the name given to him by Golden Eagle in 1995 **LOKA'DWE ICHUTAKU YUSHEDON'** Translated "Man who gets things done!" at 105 East South Street, Centerville, IN 47330

TO CONTACT THE GAD-A-BOUT

Cell: 765-960-5767 Office: 765-855-3857

Website: www.thegadabout.com

**E-Mail: raythegadabout@gmail.com

Facebook: www.facebook.com/thegadabout

COPYRIGHT BY GADCOE 2016

DISCLAIMER: The ideas and opinions expressed by the writers appearing in The Gad-a-bout are not necessarily the same as the publishers.

ADVERTISING SALES

CALL: [RAY DICKERSON](tel:765-960-5767)

CELL: 765-960-5767 OFFICE: 765-855-3857

CALL: [RICH CREASON](tel:765-215-3478)

CENTRAL INDIANA CELL: 765-215-3478

CALL: [ERNEST McCLEERY](tel:812-866-4510)

SOUTHERN INDIANA CELL: 812-866-4510

SPECIAL FEATURES

Mushrooms are where you find them/Announcing new outdoor writer Dave Wilcox who is an avid mushroom hunter by Ray Dickerson .Page 8 & 9
Climate Change is Constant (It's been around since the beginning of time and continues today) by Ray Dickerson .Page 10
Wayne County's 1940-1963 Basketball Bash February 6, 2016 by Ray Dickerson (4 Page Pull-out + 1) .Page 15-19
Eastern Indiana Gem & Geological Society's March 4-6, 2016 Spring Show and Sale by Ray & Sherry Dickerson .Page 24 & 25
Grissom Air Museum Part 3 by Ray Dickerson .Page 26 & 27
2015 Hancock County Birds and Spring 2015 by Frank Wyant .Page 28 & 29
Liberty Lions Club's Smokin' On The Water BBQ Festival By The Lake April 29 thru May 1, 2016 by Ray Dickerson. .Page 29

REGULAR FEATURED WRITERS

ROAMING THE OUTDOORS Editorial Comment & Opinion
by Ray Dickerson (Dave Wilcox new writer, New Alsace activities, Whitewater Veteran event, Moving Wall)Page 4,23 & 25
BROOKVILLE LAKE So You Wanna' Catch More Fish
by Tag Nobbe (Fishing Brookville Stilling Basin & East Fork River Above Lake)Page 5
INDIANA STATE POLICE News from the Indiana State Police
by Sgt. John D. Bowling (Indiana State Police Service, No Good Deed Goes Unpunished)Page 6
OUTDOOR HUMOR: Misfires & Snags
by Dan Graves (Sucker Punching Southern Bass)Page 7
LAKE MICHIGAN Fishing Lake Michigan
by Capt. Mike Schoonveld (DE-WINTERIZING)Page 11
GUN REPAIR Notes from Prairie Wolf Gun Repair
by Marshall Smith (April is Tax month)Page 12-13
TOURISM Visit Fayette County, IN For The Fun Of It!
by Donna Schroeder (The City of the Dead)Page 14
OUTDOORS Indiana Outdoors
by Joe Martino (Lengthening your spring turkey season is easier than you think/Neighboring states offer opportunities) . Page 20-21
OUTDOORS & TRAVEL Outdoors with Rich Creason
by Rich Creason (Australian Raptors are Arsonists)Page 22
TRAPPING Indiana State Trappers Association
by Dr. Fred Philips, DVM (End of the Line - What's next?)Page 23

GAD-A-BOUT DEPARTMENTS

Advertiser IndexPage 2
Gad's CornerPage 29-30
Brookville Lake Fishing & Hunting MapPage 30
Subscription FormPage 1
Dave Field's CartoonPage 21
Rate Sheet & Contract FormPage 30

ABOUT THE COVER PHOTOS

Top Left: A most sought after spring growth, the morel mushroom. Mushrooms are where you find them. Though elusive, if you know what to look for you will find mushrooms. I have been looking for mushrooms since I was knee high to a grasshopper. In my earliest years, long before I did any fishing or hunting I was tagging along behind Dad, Mom, Aunt Kate, my brother Bob and assorted relatives hunting mushrooms. See page 8 & 9 (Photo by Ray Dickerson)

Top Right: The Planet Earth, NASA image. It is my theory that our earth is changing dramatically due to the movement of weight on a second by second basis and that is what keeps us safely in orbit around the sun.

See more on page 10. (Credit: Image created by Reto Stockli with the help of Alan Nelson, under the leadership of Fritz Hasler)

Bottom: The Basketball Bash. I got involved with the Basketball Bash after I received an e-mail from Jim Resh on November 11th telling me about a meeting to be held at the Wayne County Historical Museum on Wednesday November 18th concerning putting together a Basketball Bash on February 6th, 2016 at the new reception room at the museum. So I accepted his invitation and after attending the event on February 6th was very happy I was there. See pages 15-19. (Photo by Ray Dickerson)

MERKAMP
Sales & Service
Monday - Friday 9 a.m. - 5 p.m.
Saturday 8:30 a.m. - Noon
OUTDOOR POWER EQUIPMENT

Jct. HWY 35 North & 38
Richmond, IN 47374
765-962-2048

CRESTLINER BOATS

VT MODEL 18

1950 SUPER HAWK

PARKSIDE MARINE & MORE, INC.
BROOKVILLE, INDIANA

"2016"

SPRING SPECIAL UNBEATABLE PRICES

230 GRAND MARINER SEL

220 SOLSTICE

7191 FOX RUN RD BROOKVILLE, IN 47012 765-647-4619
E-mail: boats@parksidemarineandmore.com Website: parksidemarineandmore.com
"We are located across the road from Mounds S.R.A. Entrance at Brookville Lake"

Roaming The Outdoors



by Ray Dickerson

THE GAD-A-BOUT IS FREE

At Advertiser locations and Advertiser support locations (see advertisers index on page 2) and read The Gad-a-bout for free on my website: www.thegadabout.com



DAVE WILCOX OWNER OF TRIANGLE WILL BEGIN APPEARING IN THE GAD-A-BOUT IN THE MAY ISSUE

Dave Wilcox (above) has agreed to begin writing a Outdoor Column in The Gad-a-bout beginning in the May issue. Dave is an all around outdoor guy, he fishes, hunts, traps and a slew of other outdoor activities and also takes care of his farm property. He's promised to take me mushroom hunting this year, the only catch is he said he had to blind fold me going in and out. I guess he doesn't want me to write about where I found mushrooms. See page 8 & 9 for a story about mushrooms in this issue and more about Dave.

NEW ALSACE CONSERVATION CLUB SAUSAGE & PANCAKE BREAKFAST

Hello,
I'm writing to tell you about our Sausage and Pancake Breakfast the New Alsace Conservation Club will be holding on Sunday, April 3rd. Breakfast will be served from 7:30 am until noon at the New Alsace American Legion Post. The menu will consist of biscuits & gravy, sausage & pancakes, home fries, ham, eggs to order, fruit, coffee & juice. Cost is \$9.00 for adults, \$4.00 for Children under 10, and Children under 3 eat free.

The American Legion Home is located north west of New Alsace off N. Dearborn Rd. on Legion Rd. Watch for signs. For more information call 812-623-2431. E-mail: backdale@gmail.com Enclosed is a flyer.

Our club is a non-profit organization and would very much appreciate, if you can announce this with

your other current events.

Directions: Take I-74 west to St. Leon Exit, S. on St. Rd.1, right on N. Dearborn Rd. 3mi. to New Alsace, right on Legion Rd. 1/4 mi. Or, east of Sunman on Eastern Ave., thru "S" turns, 4 mi. on N. Dearborn Rd., left on Legion Rd.

Thank You,

Dale A. Back, Secretary

NEW ALSACE CONSERVATION CLUB 28th ANNUAL FISHING DERBY SATURDAY MAY 7TH

Hello,

I am writing to tell you about the New Alsace Conservation Club's 28th Annual Fishing Derby that is being held on Saturday, May 7th from 7 A.M. to 5 P.M. at Lake In The Pines just west of New Alsace. Our derby is designed to encourage adults and children alike to enjoy fishing, the outdoors and practice water safety. The New Alsace Conservation Club is a non-profit organization in our 34th year of operation. We would like to invite all to join us in celebrating our 28th derby.

At our 28th Annual Fishing Derby we will be giving away derby prizes and door prizes valued at \$1500 or more to those who are registered. The derby is open to the public with an entry fee for adults and children 12 years and older of \$18.00. Children under 12 are free. The derby will run from 7am until 5pm. Rain or shine. Registration will begin at 6am on derby day and continue throughout. It should be noted that participants are not required to possess an Indiana fishing license, since they will be fishing at a private lake.

Lake In The Pines is located west of New Alsace on N. Dearborn Rd. Directions: From the east take I-74 St. Leon Exit, 3 mi. S. on St. Rd. 1, right on N. Dearborn Rd. 3.5mi. Or, from the West take I-74 Sunman Exit, 3 mi. S. on St. Rd. 101 to Sunman, left on Eastern Ave. (N. Dearborn Rd.) 4.5 mile.

We are very excited about the New Alsace Conservation Club reaching the milestone of this being our 28th fishing derby; and would like everyone to come out and enjoy a day of fishing and fun.

For more information call Lake In The Pines at 812-623-2136 or Dale Back at 812-623-2431 or E-mail: backdale@gmail.com.

www.newalsaceconservationclub.com

The New Alsace Conservation Club would very much appreciate it if you could announce this with your other local upcoming events

Sincerely yours,

Dale A. Back

Derby Committee Chairman

WHITEWATER MEMORIAL STATE PARK SPECIAL VETERAN EVENT SEPT 25, 2016 PART OF CELEBRATION OF THE 100 YEAR ANNIVERSARY INDIANA STATE PARKS

Ray,

Whitewater Memorial State Park will be having a special event on Sunday, September 25th. Part of the celebration will be connected to the 100 year anniversary for state parks. We are going to have the Mobile Vet Center in the parking lot at the Whitewater office parking lot. This is an awesome motor home type vehicle. It is an outreach program for small, rural communities like ours. The program is reaching out to veterans that haven't been to a VA clinic or has questions about the VA.

We are so proud to bring this to our area and offer help to all veterans. I want to promote this opportunity to the veterans in this area. I'm counting on you
CONTINUED ON PAGE 23

DAVE'S TRIANGLE LLC

- GUNS & AMMO •BAIT & TACKLE
- FISHING & HUNTING SUPPLIES •ICE
- SNACKS •SOFT DRINKS •FIREWOOD
- "PIZZA & SANDWICHES -LOCAL DELIVERY"

BOAT STORAGE

SUN, MON, TUE & THU 8 AM - 5 PM

WED 8 AM - NOON

FRI & SAT 8 AM - 5 PM

Hazel & Dave Wilcox Jr

2955 S. Old Dunlapville Road
Liberty, IN 47353, 765-458-7106

DAVIS TRANSMISSION

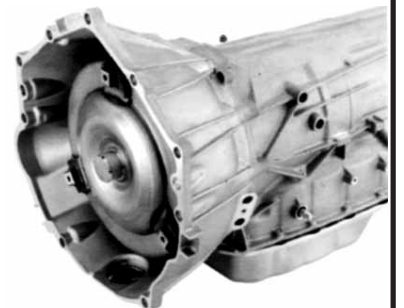

Randy Davis
Owner

765-962-9744
705 North West 5th St.
Richmond, IN 47374

grasshopper
the
grasschopper



have mower will travel
tree removal too
Lee Schoenung - Owner
Call: 765-647-5985 or
Cell: 513-218-9140
E-mail: leeschoenung@yahoo.com



Complete Auto
Repair
Service



We Sell New & Used Tires
Call for a price quote today
765-488-1470

CHECK OUR WEBSITE FOR SPECIALS

715 Sim Hodgen Pkwy
Richmond, IN 47374
Website: www.knucklebustersauto.com

Hundreds of Guns in Stock!

1Shot Sports

Guns - Muzzleloaders - Ammo - Crossbows - Targets

201 E. Main St. | Portland, IN 47371

260.766.1426

sales@1shotsports.com

Join our VIP Text Club for Special Deals
Text: 1SHOT | To: 40518

www.1ShotSports.com

C&C Webster Store & Village Post Office

Webster, Indiana
765-962-3293

ANTIQUES & GIFTS
LUNCH MEAT - SOFT DRINKS
GROCERIES - ICE - SNACKS
LIVE BAIT & TACKLE
STAMPS - PRIORITY MAIL BOXES & ENV.

PROPANE TANKS
\$19.99 + TAX
WITH EXCHANGE

Knightstown Locker, Inc. MEAT PROCESSING

Open: Mon, Wed, Fri 8-6
Tues & Thur 8-5
Sat 8-12

8037 South 575 West
Knightstown, IN 46148
(765) 345-2410 (800) 718-6010

www.ktownmeatsandcatering.com
ktownlocker@embarqmail.com

Daniel D. Titus, Owner & Operator
"Pick up your summer sausage & snack sticks at our store."



Left Photo: Stilling Basin below Brookville Lake Dam. Right Photo: Treaty Line Fisherman's Access Ramp on East Fork of Whitewater River. Bottom Right Photo: Brookville Lake Control Tower gates that control flow of water from Lake. (Author Photos)

So You Wanna Catch More Fish



by Tag Nobbe

Professional Fishing Guide

Fishing Brookville Stilling Basin & East Fork River Above Lake

No boat needed at this time of the year. April is one of those times of year where you can catch all the fish you want, as long as you have a little

insight on where to go.

One of the best shore fishing spot on the lake is not on the lake at all, its the stilling basin. The stilling basin is located just below the dam. The purpose of the stilling basin is to slow the flow of water coming out from under the lake and entering into the river. The stilling basin is connected to a huge concrete tower just on the other side of the dam with in the lake. The two are connected by a concrete pipe that runs underneath of the dam.

The tower in the lake has three gates on the side of it. One at the bottom one in the middle and one at the top. The amount of flow in the stilling basin is controlled by the opening and closing of these gates.

The temperature in the stilling basin is also controlled by the gates located on the side of the tower.

For example in the summer time when the water on the surface of the lake is 80 degrees and 100 feet down on the bottom of the lake the water temperature is 45 degrees and at the middle gate its 60 degrees. The stilling basin water temperature can be adjusted from 45 degrees to 80 degrees just by where and how much water flows through these gates.

These gates are also how all the different fish species that are in the lake end up in the stilling basin. If an unsuspecting walleye or musky is swimming to close to one of these gates on the side of the tower when water is being pulled off the lake it will be sucked in to the tower to be deposited in the stilling basin.

With in the concrete walls of the stilling basin it is 30 feet deep. This is like a big deep cold well oxygenated pond. The month of April is prime time for



you to be fishing the stilling basin.

The walleye is a fish that spawns in April and is drawn up stream to do it. As the walleye swims up the stream below Brookville lake it runs into the stilling basin. Here they find cool well oxygenated water, perfect for spawning. Over a period of time since the fish are blocked by the dam from going up stream any further they tend to meander in this area. Try to be here first thing in the morning or just right before dark. Use floating sick bait, or tip a 1/16 ounce lead head jig with a live minnow.

Another good shore fishing spot that you don't want to over look is the river that feeds the lake. In April the walleye and white bass make a run up this river also. The area I'm talking about is between liberty and Connersville Indiana on state road 44. The

CONTINUED ON PAGE 13

Perch  Smallmouth

GUIDED CHARTERS ON LAKE ERIE
WALLEYE
 April Through October
 Fishing the Western and Central Basins of Lake Erie-Ohio and Canadian Waters
 Three Fully Equipped Boats
 Two 32 ft. Blue Hills - 28 ft Bertram
 LICENSED GUIDES
 SPIN CAST - DRIFT FISH
Boytim Charter Service
 Ned Boytim
 502 E. Main St., Marblehead, OH 43440
 (419) 798-5445
 Toll Free 1-877-798-5445
 "Over 50 Years Experience"
www.walleye.com/boytim.htm

INDIANA'S LARGEST HENRY RIFLES DEALER
SOUTHEASTERN INDIANA'S
LARGEST GUN TRADER!

GUNS & TACKLE
 Est. 1977

MIKE MENTZ
 812-663-2030

1510 NORTH LINCOLN STREET, GREENSBURG, INDIANA 47240

- CASE KNIVES
- LARGE SELECTION OF CONCEAL CARRY GUNS
- TRAP GUNS - 17 HMR RIFLES
- RELOADING COMPONENTS
- HUNTING & TRAPPING SUPPLIES
- NITE LITES

"SPECIAL ORDERS & LAYAWAYS"

Pioneer Restaurant
Brookville, Indiana
 (Behind the Courthouse)
765-647-7935

- Full Breakfast Menu (Mon - Sat)
- Daily Lunch Specials
- Open Early, Open Late (Mon - Sat 7am - ? Sun 12 - 12)
- Ice & Carry-out Available
- Where good food, friends & spirits come together
- Steak, Chicken & Seafood

"Great Weekend Boat & Bike Parking"



When it comes to fueling your outdoor needs

Gasoline • Fresh Coffee • Deli Style Sandwiches • Fountain Drinks • Snacks • Sporting Goods
 Live Bait & Tackle • Guided Fishing Trip Information • Hunting & Fishing Licenses • Check Station and More



Brookville Lake Guide Service
Guide: Tag Nobbe
Phone: 765-647-4329
Cell: 765-265-3238
Web: brookvillelakeguideservice.com

Near Brookville Lake just south of Brookville on U.S. Hwy 52 (765) 647-3600

News from the Indiana State Police



by Sergeant John D. Bowling
Public Information/Recruiting Officer
Indiana State Police Service

The main purpose of the Indiana State Police, as written in our mission statement, is "To provide the most professional, effective and courteous police service possible, at all times and with every endeavor." Our badges even say Police Service, not police department.

A big part of that police service is assisting stranded motorists. As PIO Sergeant Trent Smith notes below, during the course of a year Indiana State Troopers assist nearly 200,000 motorists along Indiana roadways, while driving more than 37 million miles.

I could not begin to tell you how many tires I've changed, or folks I've transported to get gas, or hitch hikers I've given a ride to, over the last twenty five years. It's just one of the many facets of my job that I find truly rewarding, knowing that you're helping others by providing a service. It's simply what we do.

Below I've attached a press release sent out by the Bremen Post Public Information Officer, Sergeant Trent Smith. He sent out the release on 2/8 after someone anonymously posted a picture of a van with red and blue lights flashing, behind a car on the emergency strip of a state highway up north.

They also posted a caption with the picture that read "Sneaky Sneaky, watch out on the road guys." As often happens nowadays, a plethora of people jumped on the band wagon bashing police without having the facts. The facts were the van in the picture was one of our Crime Scene Technicians, in plain clothes and assigned to the Laboratory Division, who had stopped to help out a stranded motorist.

Going even further, if you really do know the facts, to stop a car in Indiana a policeman has to be in a fully marked car, or if in an unmarked car, in full uniform. The person driving by taking the picture could've seen this, had they cared to

Below is Sergeant Trent Smith's release as sent out on 2/8, in answer to the negative posts.



Van assisting motorist. (Author Photo)

However, this courtesy service can also come at a cost. Indiana troopers have been struck and killed by passing vehicles as they offered their assistance (**Winzenread 97'**, **Beal 00'**) and shot and killed as they approached stranded motorists (**Rich 07'**). It is without saying that a police service is anything but simple, routine or safe.

The police service is such an important part of who the Indiana State Police are and what they do that it was written into the department's mission statement. So when a recent Facebook posting gained notoriety for all the wrong reasons, it tore at the core values of integrity, loyalty, and community for the department and required attention.

The recently posted picture was snapped by a passing motorist of a police officer in an unmarked van with a stopped vehicle alongside the road. For this state trooper, who is assigned to the laboratory division and works as a Crime Scene Investigator, it wasn't anything he hadn't done hundreds of times before in his career. But it was the first time he had come under fire for doing the right thing and no one was more surprised than him when he saw it on the internet.

Within a few hours and then days the picture spread and the comments accumulated as the post was shared thousands of times. Perhaps it was the negative comment that was attached to the original post that sparked the fire and discussion that propelled the posting. In any event, "with current public opinion of law enforcement at a low, it is frustrating to find inaccurate reports and volatile comments on social media- but it seems all too common," commented Indiana State Police Sergeant Trent Smith.

"He simply stopped to offer his assistance to a man that was having problems with his vehicle. It seems with the creation of social media that we have lost our sense of direction as a society, as it is

now easier than ever to criticize, critique and jump to conclusions all while hiding behind a keyboard," Smith added.

What started for this trooper as nothing more than one man simply helping another, the criticisms and comments that followed have done little to undermine his resolve and more to remind him why he entered into law enforcement, to serve and protect.

It's not what you look at that matters, but how you see it. Do you see an unmarked police vehicle with an officer writing a ticket, or an officer helping a stranded motorist? Perceptions often battle one another, and unfortunately the truth often is lost.

Thank you Trent for your eloquent reply. I might add to your last line, that I think the truth is often "conveniently" lost or left out nowadays, so that others may try to further their own agenda, whatever that might be. Why let the facts get in the way of your agenda?

Trent also raises a valid point, that being you are responsible for everything you post on social media, even when you think you're being anonymous. There have been cases where people have sued others for Libel for harmful and false comments they've posted on social media.

We have also worked cases for Intimidation and Harassment, for threatening and harassing posts and comments made on social media. The long and short of it is, if you're going to post something, don't post it out of anger, and make sure you have the facts. Because in the end, you can be held responsible for everything you put out there.

For a look at our mission statement, or the obituaries for troopers killed in the line of duty while assisting motorists, just click on the links above in the story or the following links: <http://www.odmp.org/officer/1491-trooper-andrew-patrick-winzenread> or <http://www.odmp.org/officer/15350-trooper-jason-eric-beal> or <http://www.odmp.org/officer/18944-master-trooper-david-edward-rich>. Thank you for allowing all of us to SERVE all of you, as it is a true honor. Stay safe and we'll talk again next month. ■

CAMPBELLSBURG HARDWARE

Looking for something specific?
Bait & Tackle

Complete line of Plumbing, Electrical & Painting Supplies at a "Low Cost Price"

Key cutting
Special Orders are also available.

Hours: Monday thru Saturday
8:30 a.m. to 5 p.m.
Closed Sunday

206 Jefferson St.
Campbellsburg, IN 47108
Phone: (812) 755-4730

No Good Deed Goes Unpunished

During the course of a year Indiana State Troopers assist nearly 200,000 motorists along Indiana roadways while driving more than 37 million miles. The Indiana State Police categorizes this encounter with the public as a police service.

These police services cover a wide range of different circumstances but typically involve the trooper assisting a stranded motorist who has engine trouble, a flat tire or simply needs directions.

ONLINE ONLY AUCTION
Place Bids Online: April 20 - 21
at www.halderman.com

40+ Acres
EXCELLENT RECREATIONAL PROPERTY
1,300' Frontage on Whitewater River
Great for Hunting & Fishing

OPEN HOUSE: March 30
4:00 - 5:30 PM
Wayne County, IN: 3.25 miles SE of Milton

Rusty Harmeyer
765-561-1671

HALDERMAN REAL ESTATE SERVICES
800.424.2324 | halderman.com

Owners: Jerome Daniel & Lucille Schroff

HRES IN Auct. Lic. #AC69200019
AUCTIONEER: RUSSELL D. HARMAYER, IN Auct. Lic. #AU10000277

"DON'T LET THIS BE YOU"

IF YOU CHOOSE TO DRIVE IN A DRUNKEN STATE...

DON'T DO IT IN OUR STATE!

OVER THE LIMIT...UNDER ARREST

INDIANA STATE POLICE

Mendenhall
True Value
 Help Is Just Around The Corner.

THINK SPRING

125 S. W. 5th Street
 Richmond, IN 47374
 765-962-4842

RW GUNSMITH SHOP
 AGI CERTIFIED



RICCI WILLIS
 Owner

6491 S. GREENSBORO PIKE
 KNIGHTSTOWN, IN 46148
 765-345-7935
 HOURS: MON. 1:00 - 7:00 PM
 TUES.- WED.- THURS. 10:00 AM - 6:00 PM
 1st Place N of Kennard Rd on W Side, Look for sign on Pole Barn



JOHN'S GUN & TACKLE

ULTRA DOG FOOD / OWEN'S DOG BOXES
 HUNTING LIGHTS / DAN'S HUNTING CLOTHES
 GARMIN TRACKING SYS. / DOG LEADS & COLLARS

ARCHERY SUPPLIES / BOWTECH BOWS
 INDOOR ARCHERY RANGE / TECHNO HUNTING SYS.

MUCK BOOTS / RELOADING SUPPLIES
 LONG GUNS / HAND GUNS / AMMO
 FISHING TACKLE, SUPPLIES & LIVE BAIT

Owners: John & Cora Durham
 Manager: Enos Amburgey
 HOURS: Monday thru Saturday 7 am - 8 pm
 Sunday 9 am - 5 pm
 200 N. Highway 3 & 7
 North Vernon, IN 47265
 812-352-7075

BROOKVILLE LAKE GUIDE SERVICE



Tag Nobbe - Owner & Guide

6 Hour Trip Rate
 (Rates subject to change without notice)

- 1 Person \$275.00 • 2 People \$325.00
- 3 People \$375.00 • 4 People \$450.00

A non refundable \$50.00 deposit is required for booking. Cancellations within 48 hours of your date will be credited towards a future guide trip.

Fishing Seasons
 April - December Walleye Charter Seasons
 April - October Crappie Charter Season
 Mix any of the above in the same day

Contact me for your fishing trip by
 Calling my Cell: 765-265-3238
 E-mail: tag@tagnobbe.com or
 Website: www.brookvillelakeguideservice.com
 Fully licensed & insured for 17 years now.

Misfires & Snags



by Dan Graves

Sucker Punching Southern Bass

I've concluded that bass have two problems. They're lazy and they have no taste buds. If you pay attention to a bass' feeding habits you'll notice that they don't like to chase their food. They lay and wait for something to swim by and then creep slowly up behind and scarf it up. This applies mostly to the old war horses while the pre-teen and teenagers, just like us dudes were in our teen years at school dances, attack anything that moved, with vigor. If your lure suddenly stops and then begins moving off very slowly, you can most likely plan on having a rod bending good time. On the other hand, if it feels like you just drug your line through the blades of a lawn mower you'll probably drag something in that would fit on a hot dog bun. Ah, youthful exuberance.

In a previous article I described the surroundings of a fresh water lake that supposedly held a good supply of tackle busting largemouth bass. Our lodgings were in a complex of high rise buildings that house legions of senior citizens who spend their winters walking their dogs and organizing bridge parties. Since I don't have a dog and the idea of sitting at a table playing cards with a bunch of innocent looking older ladies who probably worked for casinos during their younger years, my only alternative was to fish. Since a boardwalk across the center of the lake to necessary to look over both shoulders before casting to make sure there were no pedestrians in harms way. To accidentally hook a senior lady's Pekingese and fling it into the lake would definitely be hazardous to the fisherman's health. The angler would have to be prepared to spend a lot of time in conversation as walkers stopped to ask questions.

"Ketchin' anything?"
 "Yeh, so far I've caught an old tennis shoe, size 12, and a Budweiser beer can. I'm going after the other tennis shoe, now."

Or my other favorite reply was to bemoan the difficulty of being a commercial fisherman and having to drag those monsters out of the lake, hour after hour. I considered hanging a sign around my neck to read:

"Do Not Disturb! Has Not Had Rabies Shot!"
 Day after day, sometimes with a cold wind blowing, I cast one nasty looking rubber thing after another with no effect. Other fishermen would make suggestions resulting in another trip to Bass Pro for a black or red imitation of a swamp dwelling reptilian creature. The month of January passed with nothing to show but a fouled up reel. Back to Bass Pro for a new reel. Not until I mounted the new reel did I find it wound with four pound test line. Four pound test? That wouldn't hold a honked off six inch bluegill.

But, what the heck, I thought. There's nothing in this showplace of a lake, anyway. I was fishing only to keep me from spending my time using the binoculars to watch "bird" life on the beach.

February finally rolled around and the weather warmed up a few degrees. In a zombie-like trance I plodded back to the lake, determined to catch something, even if it was nothing more than a cold. Reports of catching lunker bass from other fishermen had me believing that those guys were doing a lot more drinking than fishing. Nevertheless, I was determined to drag something out, even if it was an old tennis shoe. After trying every concoction in my tackle box, I tied on a grubby looking thing that I had found on the bank. Six inches long, bright purple with silver flakes molded in, it looked like something that had fallen off a clown outfit. Up to then I hadn't tried a small patch of lily pads about ten yards offshore. I cast what I dubbed Weird Worm at it, let it settle a few seconds and began a slow jerky retrieve. Suddenly, the line stopped and began a slow move to one side. Could those other fishermen be right? Was there something alive in this Fifth Avenue body of water? I set the hook and the rod bent double. Apparently, I had honked something off. Five seconds later, a huge lunge and the four pound test line snapped like a thread. Standing there making PHH-HFT, PHHHFT noises, I thought of the movie Jaws, when Roy Scheider said, "We're gonna need a bigger boat". There was life in the lake and I was going to need a bigger line. Back to Bass Pro and a spool of eight pound test.

Back and hopefully adequately armed, I cast Weird Worm off the board walk and promptly hooked a sixteen and-a-half inch largemouth. By now, you would have had to slit my throat to get me to part with that lure. I nurtured it carefully and over the next two weeks I caught more bass that I've caught in a lifetime. To date, I've become personally acquainted with almost thirty fish ranging from hot dog size up to twenty inches. Thanks to Weird Worm, I've sucker punched those southern bass who apparently are also color blind and have no class when it comes to what they eat. Weird Worm is now retired and will be displayed in a place of honor on my wall at home

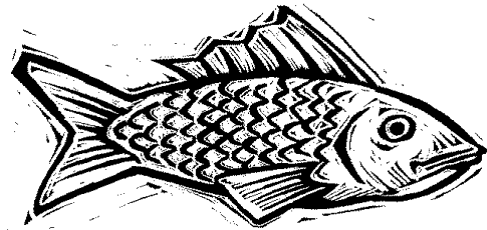

What kind of a fish am I?

VINTAGE KARTING SPECIALTY



Buy • Sell • Trade
 Wanted
 Vintage Go Karts
 Mini Bikes

411 E. Water St., Centerville, IN 47330
 765-969-7756
GordonJuhasz@gmail.com

Over Twenty Years Experience
 Insured • Free Estimates • Residential & Commercial

Serving Central & Southern Indiana



Brian Robbins
 Owner
 Email: bnr_roofing@yahoo.com

Decks • Porches • Vinyl Siding • Soffit • Complete Cleanup
CALL 812-701-1705



Left Photo: A prize worth more than a pot of gold this size, yellow sponge morel mushrooms. This photo was taken in 2003 in southern Indiana by the late Bud Clark. Bud owned Bud's Bait & Tackle in Nineveh, IN. Right Photo: Last April 21, 2015 I took this photo at 10:04 a.m., holding this bowl of several mushroom species was Dave Wilcox. I stopped by Dave's Triangle to see if he had found any mushrooms. In the bowl he had 1 gray sponge, 6 mule tails and the balance were black sponge morel. I thanked him and headed for the woods. I got a lot of exercise, which would have made my doctor proud, but didn't find one mushroom. (Photo by Ray Dickerson)

Mushrooms are where you find them

by Ray Dickerson

I have been looking for mushrooms since I was knee high to a grasshopper. In my earliest years, long before I did any fishing or hunting I was tagging along behind Dad, Mom, Aunt Kate, my brother Bob and assorted relatives. Recollections that come to mind readily was of my falling over a log or stepping in a hole and finding myself rolling down a big hill. Or when Dad and Bob easily stepped across a small stream and I ended up tumbling from a rock or log into the stream. My big brother Bob seemed to find that very funny. One time Bob and I was looking in a section of the woods behind Cheeseman's where pigs were present. Dad hollered at us telling us we wouldn't find any mushrooms there. Bob and I found two yellow morel mushrooms that were about eight inches tall. When we got home we took them to Emory Short's grocery on Walnut Street in Centerville to show Aunt Kate, our prize mushrooms. Emory gave us a dollar a piece for them. A dollar back then was a lot of money. When we got home we showed dad the money we got for the two mushrooms. Later on when I was older and went mushroom hunting with Dad. Well wait a minute it was uncanny, Dad could spot a mushroom at a distance and when hunting he rarely came home with less than the limit of squirrels or rabbits. Back to mushroom hunting, we were walking along a stream, him on one side and me on another. All of a sudden he said, Raymond, are you going to stomp on them mushrooms or stop and pick them. I looked down and behind me were several yellow sponge I'd stepped on. Dad was a born outdoorsman. We hunt-

ed and fished from the time I was old enough to tag along until he couldn't anymore. I remember well the first .22 rifle he got me. I think I was ten years old. Before I could use it I had to rub linseed oil into the stock for what seemed like ages, then I couldn't fire or load a bullet into it until I dry fired it for several trips to the woods. I miss him.

Beginning next month here in The Gad-a-bout I've talked a friend of mine, Dave Wilcox, who owns Dave's Triangle LLC to write a new column for me. He very much reminds me of Dad, in that he is a true outdoorsman in his own right. Dave grew up in Yankeetown fishing, hunting, trapping, hunting mushrooms along the East Fork of the Whitewater River and Brookville Lake area. See photo at right, Dave is holding two really nice yellow sponge mushrooms and has a mother lode of them in the bucket and laying in front of him. I've asked him to take me mushroom hunting since I first met him, but to date I've not been that fortunate. The other day he told me he might take me some time, but he would have to blindfold me until we got into the woods.

I haven't found any mushrooms for the past 3 years. Four years ago I found 8, just enough for one meal. When Dad and I hunted them, we ate them quite regularly. But for some time I have only ate one meal of the ones I found and gave the rest to farmers who let me hunt in their woods, friends and other's who couldn't get out in the woods any more. After I met Weeb Eubank back in 1983 (my cousin) I took him several batches. He and his wife, Lucy, really loved the wild mushrooms.

Getting back to Dave Wilcox. On the next page are several photos Dave



Dave Wilcox, April 20, 2006 with a mother lode of yellow sponge mushrooms. (Dave Wilcox Photo)

FOR SALE

BARTON'S BAY BOAT STORAGE & SERVICE

BOAT STORAGE AVAILABLE NOW
ACROSS THE ROAD FROM BROOKVILLE LAKE

10055 SR 101, Brookville, IN 47012 Phone/Fax 765-647-5647
E-mail: bartonsbay@bartonsbay.com / Website: www.bartonsbay.com
BUSINESS OPPORTUNITY
Check out our sales information at www.forsale.bartonsbay.com

Bozarth Country Store

On The SALAMONIE RESERVOIR

<p>Fishing Tackle Hunting Equip Camping Supplies Boating Equip Save BIG</p>		<p>LARGEST Selection of Cast Iron</p> <p style="text-align: center;">BOZARTH 2016 CRAPPIE TOURNEYS Sat April 30th / Sat June 4th Sat Sept. 10th / Sat Sept. 24th For Info Call Ryan 765-981-4522</p>
--	--	--

SEASONAL CAMPSITES AVAILABLE
Seasonal Rates - Full Hookups
"SIGN UP NOW"

1 mile east & 1 mile north of Lincolnville

We Have A Large Breakfast & Sandwich Menu

<p>Campstore / Grocery Fishing Tackle, Live Bait & License Camping & Hunting Supplies Cold & Hot Drinks Ice - Pizza - Sausage - Hot Dogs Snacks & Sandwiches</p>	<p>Hunting Check In Station Banquet Room w/Kitchenette Arcade Game Room Showers (All Year) Boat Storage (Inside) LP Gas Refill Station</p>
--	---

765-981-4522
7309 East 400 South
Wabash County
Lagro, IN 46941

We Proudly Carry Bass Pro Products
Save on Shipping

Open All Year - 6:00 AM to Dusk



A black sponge standing proudly above a mix of leaves and ground clutter has caught Dave's eye. (Dave Wilcox Photo)

has taken of his mushroom finds. Above at the far right is a photo of a shed (deer antler) he looks for while hunting mushrooms. A lot of people scour the country side looking for deer antlers that have been shed by the deer. After the antlers are shed by the deer, the ones that aren't found by collectors disappear from sight. The discarded antlers represent a source of calcium, phosphorus and other minerals and are often gnawed upon by small animals, including squirrels,



Above is a double of black sponge morel he found. (Dave Wilcox Photo)

porcupines, rabbits and mice. This is more common among animals inhabiting regions where the soil is deficient in these minerals. Antlers shed in oak forest inhabited by squirrels are rapidly chewed to pieces by them. This is the reason why the countryside isn't littered with deer antlers from year to year. Mother Earth has a cure for all that happens on her turf.

Dave's first column will appear in the May Gad-a-bout. Dave told me he would do the best he could do, but added that he's not a writer. I told him he would do fine.

Let me tell you all something about writing. Anyone can write, but many who try stumble over the misconstrued notion that you have to be a scholar to be a good writer. Many of the writers who have written columns in The Gad-a-bout and some still do, weren't writers in the beginning. All it takes to be a good writer is knowing the subject you are writing about, sitting



Dave Wilcox told me as he is looking for spring mushrooms he also looks for sheds. (Dave Wilcox Photo)

down and writing about it. It's that simple!

My first column appeared in a local weekly newspaper after I asked the publisher/editor about writing an outdoor column for his paper. I wanted to write about outdoor subjects that I thought weren't getting out to the people who enjoyed the outdoors. The name of my column was "Indiana Outdoors." I wrote that column off and on for 18 years.

My high school diploma read, General. The only thing I studied that helped me become a writer was two years of typing, art club and an English teacher who encouraged me to write short stories and read them in front of the class, Mrs. Edna Pickett.

I have been a published writer since July 1972, if I can do it, you can too. It's easier today though then ever before with social media, twitter, etc. Just be careful what you write about online and where you put it. Once you push send.....it's on its way. ■

REBATES UP TO \$1,400 ON RANGER XP 900

OR FINANCING AS LOW AS 1.99% FOR 60 MONTHS

REBATES UP TO \$800 ON RANGER 570

POLARIS

STOP BY TODAY FOR INCREDIBLE OFFERS AND UNBEATABLE SERVICE.

Rogon EQUIPMENT INC.

765-966-9801

4737 NATIONAL RD W RICHMOND, IN

VISIT POLARIS.COM FOR MORE OFFERS.

RESTRICTIONS: Rebates may be applied to select new 2015-2016 models. Offers valid from 3/26/16 - 4/30/16. Financing available on select new 2015-2016 Polaris® 50-Head Vehicles. Lease models excluded. Does not apply to prior purchases. APR as low as 1.99% for 60 months requires monthly payments. In lieu of rebates, valid on Approved Financing of \$5,000 or more of select new Polaris® 470, 570, 670, 770, 870, 970, 1070, 1170, 1270, 1370, 1470, 1570, 1670, 1770, 1870, 1970, 2070, 2170, 2270, 2370, 2470, 2570, 2670, 2770, 2870, 2970, 3070, 3170, 3270, 3370, 3470, 3570, 3670, 3770, 3870, 3970, 4070, 4170, 4270, 4370, 4470, 4570, 4670, 4770, 4870, 4970, 5070, 5170, 5270, 5370, 5470, 5570, 5670, 5770, 5870, 5970, 6070, 6170, 6270, 6370, 6470, 6570, 6670, 6770, 6870, 6970, 7070, 7170, 7270, 7370, 7470, 7570, 7670, 7770, 7870, 7970, 8070, 8170, 8270, 8370, 8470, 8570, 8670, 8770, 8870, 8970, 9070, 9170, 9270, 9370, 9470, 9570, 9670, 9770, 9870, 9970, 10070, 10170, 10270, 10370, 10470, 10570, 10670, 10770, 10870, 10970, 11070, 11170, 11270, 11370, 11470, 11570, 11670, 11770, 11870, 11970, 12070, 12170, 12270, 12370, 12470, 12570, 12670, 12770, 12870, 12970, 13070, 13170, 13270, 13370, 13470, 13570, 13670, 13770, 13870, 13970, 14070, 14170, 14270, 14370, 14470, 14570, 14670, 14770, 14870, 14970, 15070, 15170, 15270, 15370, 15470, 15570, 15670, 15770, 15870, 15970, 16070, 16170, 16270, 16370, 16470, 16570, 16670, 16770, 16870, 16970, 17070, 17170, 17270, 17370, 17470, 17570, 17670, 17770, 17870, 17970, 18070, 18170, 18270, 18370, 18470, 18570, 18670, 18770, 18870, 18970, 19070, 19170, 19270, 19370, 19470, 19570, 19670, 19770, 19870, 19970, 20070, 20170, 20270, 20370, 20470, 20570, 20670, 20770, 20870, 20970, 21070, 21170, 21270, 21370, 21470, 21570, 21670, 21770, 21870, 21970, 22070, 22170, 22270, 22370, 22470, 22570, 22670, 22770, 22870, 22970, 23070, 23170, 23270, 23370, 23470, 23570, 23670, 23770, 23870, 23970, 24070, 24170, 24270, 24370, 24470, 24570, 24670, 24770, 24870, 24970, 25070, 25170, 25270, 25370, 25470, 25570, 25670, 25770, 25870, 25970, 26070, 26170, 26270, 26370, 26470, 26570, 26670, 26770, 26870, 26970, 27070, 27170, 27270, 27370, 27470, 27570, 27670, 27770, 27870, 27970, 28070, 28170, 28270, 28370, 28470, 28570, 28670, 28770, 28870, 28970, 29070, 29170, 29270, 29370, 29470, 29570, 29670, 29770, 29870, 29970, 30070, 30170, 30270, 30370, 30470, 30570, 30670, 30770, 30870, 30970, 31070, 31170, 31270, 31370, 31470, 31570, 31670, 31770, 31870, 31970, 32070, 32170, 32270, 32370, 32470, 32570, 32670, 32770, 32870, 32970, 33070, 33170, 33270, 33370, 33470, 33570, 33670, 33770, 33870, 33970, 34070, 34170, 34270, 34370, 34470, 34570, 34670, 34770, 34870, 34970, 35070, 35170, 35270, 35370, 35470, 35570, 35670, 35770, 35870, 35970, 36070, 36170, 36270, 36370, 36470, 36570, 36670, 36770, 36870, 36970, 37070, 37170, 37270, 37370, 37470, 37570, 37670, 37770, 37870, 37970, 38070, 38170, 38270, 38370, 38470, 38570, 38670, 38770, 38870, 38970, 39070, 39170, 39270, 39370, 39470, 39570, 39670, 39770, 39870, 39970, 40070, 40170, 40270, 40370, 40470, 40570, 40670, 40770, 40870, 40970, 41070, 41170, 41270, 41370, 41470, 41570, 41670, 41770, 41870, 41970, 42070, 42170, 42270, 42370, 42470, 42570, 42670, 42770, 42870, 42970, 43070, 43170, 43270, 43370, 43470, 43570, 43670, 43770, 43870, 43970, 44070, 44170, 44270, 44370, 44470, 44570, 44670, 44770, 44870, 44970, 45070, 45170, 45270, 45370, 45470, 45570, 45670, 45770, 45870, 45970, 46070, 46170, 46270, 46370, 46470, 46570, 46670, 46770, 46870, 46970, 47070, 47170, 47270, 47370, 47470, 47570, 47670, 47770, 47870, 47970, 48070, 48170, 48270, 48370, 48470, 48570, 48670, 48770, 48870, 48970, 49070, 49170, 49270, 49370, 49470, 49570, 49670, 49770, 49870, 49970, 50070, 50170, 50270, 50370, 50470, 50570, 50670, 50770, 50870, 50970, 51070, 51170, 51270, 51370, 51470, 51570, 51670, 51770, 51870, 51970, 52070, 52170, 52270, 52370, 52470, 52570, 52670, 52770, 52870, 52970, 53070, 53170, 53270, 53370, 53470, 53570, 53670, 53770, 53870, 53970, 54070, 54170, 54270, 54370, 54470, 54570, 54670, 54770, 54870, 54970, 55070, 55170, 55270, 55370, 55470, 55570, 55670, 55770, 55870, 55970, 56070, 56170, 56270, 56370, 56470, 56570, 56670, 56770, 56870, 56970, 57070, 57170, 57270, 57370, 57470, 57570, 57670, 57770, 57870, 57970, 58070, 58170, 58270, 58370, 58470, 58570, 58670, 58770, 58870, 58970, 59070, 59170, 59270, 59370, 59470, 59570, 59670, 59770, 59870, 59970, 60070, 60170, 60270, 60370, 60470, 60570, 60670, 60770, 60870, 60970, 61070, 61170, 61270, 61370, 61470, 61570, 61670, 61770, 61870, 61970, 62070, 62170, 62270, 62370, 62470, 62570, 62670, 62770, 62870, 62970, 63070, 63170, 63270, 63370, 63470, 63570, 63670, 63770, 63870, 63970, 64070, 64170, 64270, 64370, 64470, 64570, 64670, 64770, 64870, 64970, 65070, 65170, 65270, 65370, 65470, 65570, 65670, 65770, 65870, 65970, 66070, 66170, 66270, 66370, 66470, 66570, 66670, 66770, 66870, 66970, 67070, 67170, 67270, 67370, 67470, 67570, 67670, 67770, 67870, 67970, 68070, 68170, 68270, 68370, 68470, 68570, 68670, 68770, 68870, 68970, 69070, 69170, 69270, 69370, 69470, 69570, 69670, 69770, 69870, 69970, 70070, 70170, 70270, 70370, 70470, 70570, 70670, 70770, 70870, 70970, 71070, 71170, 71270, 71370, 71470, 71570, 71670, 71770, 71870, 71970, 72070, 72170, 72270, 72370, 72470, 72570, 72670, 72770, 72870, 72970, 73070, 73170, 73270, 73370, 73470, 73570, 73670, 73770, 73870, 73970, 74070, 74170, 74270, 74370, 74470, 74570, 74670, 74770, 74870, 74970, 75070, 75170, 75270, 75370, 75470, 75570, 75670, 75770, 75870, 75970, 76070, 76170, 76270, 76370, 76470, 76570, 76670, 76770, 76870, 76970, 77070, 77170, 77270, 77370, 77470, 77570, 77670, 77770, 77870, 77970, 78070, 78170, 78270, 78370, 78470, 78570, 78670, 78770, 78870, 78970, 79070, 79170, 79270, 79370, 79470, 79570, 79670, 79770, 79870, 79970, 80070, 80170, 80270, 80370, 80470, 80570, 80670, 80770, 80870, 80970, 81070, 81170, 81270, 81370, 81470, 81570, 81670, 81770, 81870, 81970, 82070, 82170, 82270, 82370, 82470, 82570, 82670, 82770, 82870, 82970, 83070, 83170, 83270, 83370, 83470, 83570, 83670, 83770, 83870, 83970, 84070, 84170, 84270, 84370, 84470, 84570, 84670, 84770, 84870, 84970, 85070, 85170, 85270, 85370, 85470, 85570, 85670, 85770, 85870, 85970, 86070, 86170, 86270, 86370, 86470, 86570, 86670, 86770, 86870, 86970, 87070, 87170, 87270, 87370, 87470, 87570, 87670, 87770, 87870, 87970, 88070, 88170, 88270, 88370, 88470, 88570, 88670, 88770, 88870, 88970, 89070, 89170, 89270, 89370, 89470, 89570, 89670, 89770, 89870, 89970, 90070, 90170, 90270, 90370, 90470, 90570, 90670, 90770, 90870, 90970, 91070, 91170, 91270, 91370, 91470, 91570, 91670, 91770, 91870, 91970, 92070, 92170, 92270, 92370, 92470, 92570, 92670, 92770, 92870, 92970, 93070, 93170, 93270, 93370, 93470, 93570, 93670, 93770, 93870, 93970, 94070, 94170, 94270, 94370, 94470, 94570, 94670, 94770, 94870, 94970, 95070, 95170, 95270, 95370, 95470, 95570, 95670, 95770, 95870, 95970, 96070, 96170, 96270, 96370, 96470, 96570, 96670, 96770, 96870, 96970, 97070, 97170, 97270, 97370, 97470, 97570, 97670, 97770, 97870, 97970, 98070, 98170, 98270, 98370, 98470, 98570, 98670, 98770, 98870, 98970, 99070, 99170, 99270, 99370, 99470, 99570, 99670, 99770, 99870, 99970, 100070, 100170, 100270, 100370, 100470, 100570, 100670, 100770, 100870, 100970, 101070, 101170, 101270, 101370, 101470, 101570, 101670, 101770, 101870, 101970, 102070, 102170, 102270, 102370, 102470, 102570, 102670, 102770, 102870, 102970, 103070, 103170, 103270, 103370, 103470, 103570, 103670, 103770, 103870, 103970, 104070, 104170, 104270, 104370, 104470, 104570, 104670, 104770, 104870, 104970, 105070, 105170, 105270, 105370, 105470, 105570, 105670, 105770, 105870, 105970, 106070, 106170, 106270, 106370, 106470, 106570, 106670, 106770, 106870, 106970, 107070, 107170, 107270, 107370, 107470, 107570, 107670, 107770, 107870, 107970, 108070, 108170, 108270, 108370, 108470, 108570, 108670, 108770, 108870, 108970, 109070, 109170, 109270, 109370, 109470, 109570, 109670, 109770, 109870, 109970, 110070, 110170, 110270, 110370, 110470, 110570, 110670, 110770, 110870, 110970, 111070, 111170, 111270, 111370, 111470, 111570, 111670, 111770, 111870, 111970, 112070, 112170, 112270, 112370, 112470, 112570, 112670, 112770, 112870, 112970, 113070, 113170, 113270, 113370, 113470, 113570, 113670, 113770, 113870, 113970, 114070, 114170, 114270, 114370, 114470, 114570, 114670, 114770, 114870, 114970, 115070, 115170, 115270, 115370, 115470, 115570, 115670, 115770, 115870, 115970, 116070, 116170, 116270, 116370, 116470, 116570, 116670, 116770, 116870, 116970, 117070, 117170, 117270, 117370, 117470, 117570, 117670, 117770, 117870, 117970, 118070, 118170, 118270, 118370, 118470, 118570, 118670, 118770, 118870, 118970, 119070, 119170, 119270, 119370, 119470, 119570, 119670, 119770, 119870, 119970, 120070, 120170, 120270, 120370, 120470, 120570, 120670, 120770, 120870, 120970, 121070, 121170, 121270, 121370, 121470, 121570, 121670, 121770, 121870, 121970, 122070, 122170, 122270, 122370, 122470, 122570, 122670, 122770, 122870, 122970, 123070, 123170, 123270, 123370, 123470, 123570, 123670, 123770, 123870, 123970, 124070, 124170, 124270, 124370, 124470, 124570, 124670, 124770, 124870, 124970, 125070, 125170, 125270, 125370, 125470, 125570, 125670, 125770, 125870, 125970, 126070, 126170, 126270, 126370, 126470, 126570, 126670, 126770, 126870, 126970, 127070, 127170, 127270, 127370, 127470, 127570, 127670, 127770, 127870, 127970, 128070, 128170, 128270, 128370, 128470, 128570, 128670, 128770, 128870, 128970, 129070, 129170, 129270, 129370, 129470, 129570, 129670, 129770, 129870, 129970, 130070, 130170, 130270, 130370, 130470, 130570, 130670, 130770, 130870, 130970, 131070, 131170, 131270, 131370, 131470, 131570, 131670, 131770, 131870, 131970, 132070, 132170, 132270, 132370, 132470, 132570, 132670, 132770, 132870, 132970, 133070, 133170, 133270, 133370, 133470, 133570, 133670, 133770, 133870, 133970, 134070, 134170, 134270, 134370, 134470, 134570, 134670, 134770, 134870, 134970, 135070, 135170, 135270, 135370, 135470, 135570, 135670, 135770, 135870, 135970, 136070, 136170, 136270, 136370, 136470, 136570, 136670, 136770, 136870, 136970, 137070, 137170, 137270, 137370, 137470, 137570, 137670, 137770, 137870, 137970, 138070, 138170, 138270, 138370, 138470, 138570, 138670, 138770, 138870, 138970, 139070, 139170, 139270, 139370, 139470, 139570, 139670, 139770, 139870, 139970, 140070, 140170, 140270, 140370, 140470, 140570, 140670, 140770, 140870, 140970, 141070, 141170, 141270, 141370, 141470, 141570, 141670, 141770, 141870, 141970, 142070, 142170, 142270, 142370, 142470, 142570, 142670, 142770, 142870, 142970, 143070, 143170, 143270, 143370, 143470, 143570, 143670, 143770, 143870, 143970, 144070, 144170, 144270, 144370, 144470, 144570, 144670, 144770, 144870, 144970, 145070, 145170, 145270, 145370, 145470, 145570, 145670, 145770, 145870, 145970, 146070, 146170, 146270, 146370, 146470, 146570, 146670, 146770, 146870, 146970, 147070, 147170, 147270, 147370, 147470, 147570, 147670, 147770, 147870, 147970, 148070, 148170, 148270, 148370, 148470, 148570, 148670, 148770, 148870, 148970, 149070, 149170, 149270

CLIMATE CHANGE IS CONSTANT

by Ray Dickerson

From time to time I've had thoughts that I wasn't thinking about, materialize in my mind out of nowhere.

The late Henry M. "Hank" Stock aka Golden Eagle, my very good Indian friend I met for the first time at Frontier Days Rendezvous at Treaty Line Pioneer Village in September of 1993 told me there were reasons for those thoughts, it was the Great Spirit's way of communicating with us.

In this article I call the Planet Earth, Mother Earth.

I'm not sure where these thoughts come from, but this particular thought has wandered around in my mind for a very long time, years to be exact. I haven't known what to do with it, it seemed important, it was rooted in weight movement and the balance of the earth. For some time I thought it was related to all the sink holes, oil, gas and ore removed from the earth, being replaced by water in its place, but it had to be bigger than that.

Here is the thought that has stayed in my mind the longest, it's about movement of weight, constantly moving second by second, keeping Mother Earth balanced on its axis so it can orbit around the sun instead of wandering off into space. Without climate change our earth would be void of life.

Last week I wrote about this in my weekly column in the Western Wayne Newspaper. Haven't heard one comment about it from anyone.

For this article in The Gad-a-bout though I'm going to write more in depth of my feelings toward climate change. This notion that climate change is man made, is absurd.

I have always believed that common sense was a great attribute to have and have tried to use it as often as possible. There are times though when I've wondered if others know what common sense is, due to their questionable actions.

Just yesterday it was reported by one of the news channels that President Obama was considering involving the Department of Justice in prosecuting people for the offense of man made climate change denial.

Climate change was the subject of a conversation on CNN recently too. A young fellow said he believed that climate change was man made and that is why he is voting for Hillary Clinton, because she has said she believes man is responsible for climate change in her campaign speeches.

Here is my thoughts on climate change: Mother Earth had its beginning a long time ago when man wasn't present. Climate change was created by the forces that created our universe. Had there not been climate change at the time of our earth's birth, it would be similar to the moon, desolate and uninhabitable.

Due to climate change though from the beginning of mother earth, it is a living planet that is still changing. Other than weight, mankind is of little consequence to the changes of Mother Earth.

Climate change has been constant from the beginning of Mother Earth, enjoy it - you can do little to change it.

Here is the basis for my thought - Mother Earth has been changing dramatically since the beginning of time, due to the movement of weight on a second by second basis and that is what keeps us safely in



The Planet Earth, NASA image. (Credit: Image created by Reto Stockli with the help of Alan Nelson, under the leadership of Fritz Hasler)

orbit around the sun. Water, Wind and Fire are the forces of Mother Earth. These natural weight movers are water in the liquid form of rain, rivers, lakes and oceans or the solid form of snow and ice; Wind in the form of a breeze, a gust, a dirt devil, a tornado, a hurricane or a cyclone; And Fire in the form of a single match, a bonfire, a forest fire, a fire caused by lightning or the internal fire inside the core of our earth causing volcanic eruptions around the earth.

Living creatures including humans were born on this earth to help move weight. Billions of insects, animals, reptiles, birds, sea creatures and humans are constantly on the move world wide. What causes the movements, migrations, population explosions and/or a sudden decrease in population? The need for immediate earth weight gain or loss to balance Mother Earth in its orbit around the sun. The calculations of weight movement on earth is staggering for mortals to figure out, but we don't have that responsibility, Mother Earth has that responsibility and we mortals only have to Believe.

Today, 03-12-16, a massive flood is in progress in Arkansas, Louisiana, Mississippi and Texas, 20.97 inches of rain in one area in a single rainfall. The Mississippi river will be at a record level for this time of the year. That's a lot of weight added all of a sudden, ever wonder why?

The largest ever cyclone hit Fiji a few weeks ago, the highest wind speed on record, hundreds of homes leveled and blown away. That's a lot of weight subtracted all at once, ever wonder why?

California was denied rainfall for several years causing the longest drought ever recorded, ever wonder why?

Volcano eruptions happen instantly with or without warnings all around Mother Earth, ever wonder why?

The ice pack at the North Pole is melting causing the loss of a lot of weight, ever wonder why?

Think about it.

My answer, weight movement second by second determined by _____. You fill in the blank.

It amazes me when there is something in the natural world that goes awry, the balance of nature is never suggested as the reason. Today man kind believes there has to be a man made cure for everything that happens. We would be well advised in some cases to let the natural world take care of its own problems. Instant cures only happen in the movies.

McDonald's Bait and Tackle

Live & Artificial Bait
Open 7 Days at 7 A.M.
Home Processing Supplies
Excellent Sausage & Jerky Seasonings,
Casings, etc. — *"Check us out!"*

**15 W. Grant Street
Knightstown, IN 46148
765-345-2074**

RED WING SHOES

MILROY SHOES

Mastercard - Visa

**9214 S. State Rd. 3, Milroy, IN 46156
(765) 629-2109**

Mon-Thur 8 - 5 / Fri 8 - 6 / Sat 8 - 3 / Closed Sun

Rick & Jeff's Floor Coverings, Inc. *We Will Not Be Undersold!*

For All Your Floor Covering Needs
(812) 754-0888
Now Carrying In Stock Area Rugs!
12 Styles To Choose From!
kathy ireland

Shades Of America

SPINMASTER HOME GALLERY beaulieu HOMCO
Sutton Philadelphia Tarkett
Shaw Queen BRUCE
MANNINGTON

Hwy. 56 East • Scottsburg, IN 47170

Riverside Sporting Goods

**1811 N. Washington St.
Marion, IN 46952 • 765-662-1590**

Family Owned & Operated
Manager: Chad Phillips

Fishing • Live Bait • Tackle • Propane
Ice • Hunting • Guns • Ammo • Archery
Personal Protection • Canoe Rental
U-Haul Rental - 765-664-7939

dry dock MARINA
at Prairie Creek

EXPERIENCE THE OUTBOARD ENGINE THAT'S **ECO-FRIENDLY AND WALLET-FRIENDLY.**

The facts are in. Evinrude E-TEC outboards are unbeatable when it comes to clean and quiet performance, even against 4-strokes. We've passed them all and they never stand a chance. Evinrude E-TEC is the only outboard engine that goes 3 times as far with the dealer scheduled maintenance.

EXPERIENCE THE ENTIRE LINE-UP AT EVINRUDE.COM

EVINRUDE E-TEC

POLAR KRAFT

OUR MOTTO
**YOU WANT IT - WE CAN GET IT
YOU BREAK IT - WE CAN FIX IT**
Most all Makes & Models

25yrs of Technical Service we R
Equipped enough for the BIG needs
Stay small enough for YOUR needs

Godfrey PONTON BOATS

POLAR KRAFT

FISHING BOATS

SALES SERVICE RENTALS
Just 15 minutes outside Muncie, IN @
6700 S CR 560 EAST, SELMA, IN
765-286-4976

J & M Sporting Goods
Veteran Owned

Firearms Our Specialty

**Rifles, Shotguns, Pistols, Ammo
Gunsmithing**

Hours: Tuesday-Saturday, 10 AM to 6 PM
BUY, SALE, and TRADE

**3527 West US 40
Greenfield, IN 46140
317-318-9013**



Frame's Outdoor
Remington COUNTRY

- Fishing • Hunting
- Rifles • Shotguns • Gun Safes
- Camping • Firewood
- Archery Range • Live Bait
- Western Wear & Gifts

Whitewater State Park
Brookville Lake
Hunting & Fishing Headquarters
Deer and Turkey Check-In Station
Call: 765-458-7227
855 South State Road 101
Liberty, IN 47353
Website: www.frames-outdoor.com
E-mail: framesoutdoor@aol.com

Fishing Lake Michigan

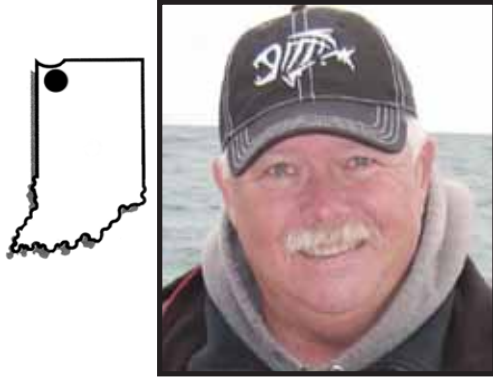

by Capt. Mike Schoonveld
DE-WINTERIZING

I've written "winterizing" articles dozens of times over the years. Nothing assures a trouble free start to the boating/fishing season more than a perfect job of winterizing when you put ol' Wavewhacker to bed for winter storage.

But even with perfect winterization, the results can be less than perfect when you uncover the worthy vessel and get ready for the upcoming season. Now is the time to properly de-winterize boats to make sure it is functional before heading out on the water.

Do it now. When nice weekends start popping up, be de-winterized ready to take advantage. Instead of using the first nice weekend to get the boat ready or worse, get to the lake before finding out you have a problem, get it ready now.

First, try to drain out any water that may have found its way into your boat during the winter season. This will help avoid the accumulation of mold, rust, and any potential damage to components as temperatures rise. If you are lucky enough to have a covered storage barn this won't be an issue. If you are like many, you shrink-wrap or tarp ol' Wavewhacker and let it weather the winter.

Remember the cold and blowing snow? Some of that probably found a crack in your cover.

Check the battery to see if it can still hold a charge after the cold winter months. This can be done by taking a conventional car battery charger and checking if the battery holds 100 percent of the charge that it is given. If the battery has a full charge and the motor still won't turn on, replace any fuses that may have broken during the winter.

Check fuel lines for cracks/leaks or signs of rodents chewing on them, make sure hoses are connected, check fittings and connections to make sure they are tight, make sure plugs are in good shape and installed before heading out on the water.

Next, take a look at all boating safety equipment to ensure it is still serviceable. Boat safety items are required and include personal flotation devices, a sound making device, fire extinguisher, navigation lights, and 2016 boat registration with visible registration numbers. This is an important step because during the winter months many of these items are subject to cold weather elements which can cause them to wear or become unserviceable. Even boats stored indoors are subject to mouse attacks.

Most important to me is to make sure the motor starts and runs. With water muffs properly installed and working on the lower unit, start your boat at home to make sure it runs. Don't think you can "dry-start" the motor and then shut it down. A few seconds of operating a water pump with no water in it can ruin the assembly. It's a lot less embarrassing to have a boat not start in the driveway than on a crowded dock.

Check your fishing license expiration date. Years ago the MDNR switched the expiration date for licenses from a calendar year to a year running from April first to March 31st. Available at many locations or on-line, buy your license, make some copies and be ready. I have copies of my license in my tow vehicle, in my wallet and in the boat.

When you do get on the water for the first time, keep an eye on everything. Your first time out isn't called the "shakedown" cruise for nothing. Keep an

eye on the bilge, monitor any engine monitoring gauges you have, especially the engine temperature. Water pump impellers dry out over the winter and might not be working in the spring like they did in the fall. There is no substitute for the professional advice of a local boat service center. If there are any concerns about the condition of a boat or ability to be functional out on the water for your first outing, call your local boat factory authorized center for professional advice.



Proper "de-wintering" a boat can insure your first outing this spring is hassle-free. (Author Photo)

THE END

CAPTAIN MIKE SCHOONVELD
AFFORDABLE LAKE MICHIGAN SALMON FISHING IN INDIANA
FOR 1 TO 4 PEOPLE
Tackle Furnished, Fish Cleaned
www.brother-nature.com



Brother Nature Charters
1-877-SALMON-5

STEVE'S MARINE



BENNINGTON

LUNO
THE ULTIMATE FISHING EXPERIENCE

South Bay
Memories for a Lifetime...

AT BROOKVILLE LAKE • 765-458-7527
1156 WEST DUNLAPSVILLE ROAD., LIBERTY, IN

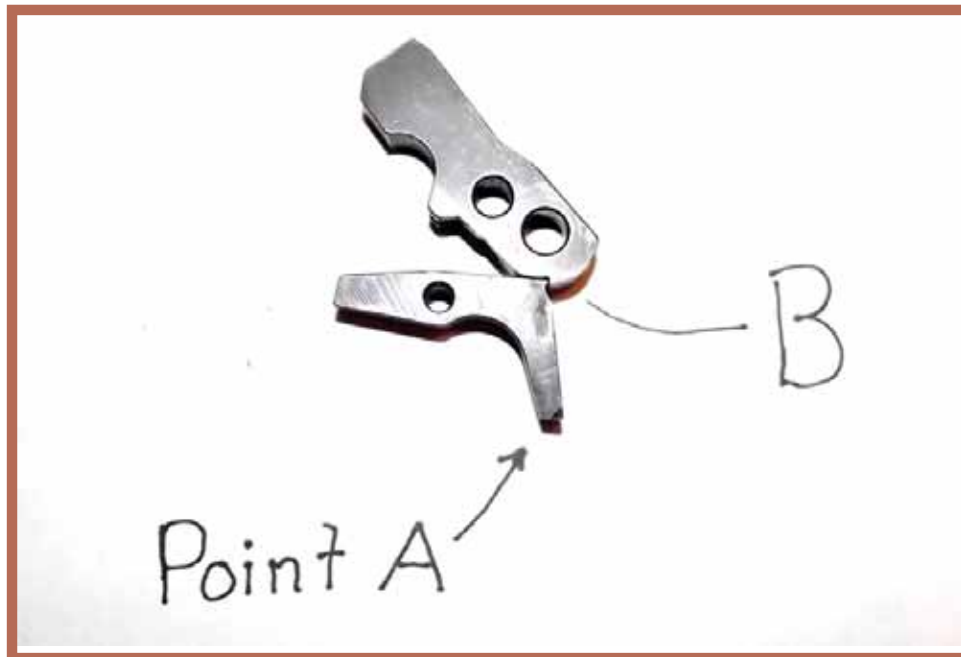

Left Photo: "This is a picture of the hammer (top) and the sear (bottom) engagement in the full-cock notch of the hammer. Note how deeply the sear sets in the notch. Looking closely you can see that there is metal of the notch extending below the sear nose. I've labeled what I call the sear Safety Leg with point A. That point sets on top of the cross-bolt when in the on position. When the hammer is in the uncocked position the area I've labeled as Point B presses against the top of the sear holding it down and in the disconnect position and blocks the safety from being placed in the on position. Do you have a stock Ruger 10/22 that allows the safety to be pressed on when the hammer is in the uncocked position? That could mean you have a gun that is unsafe." Right Photo: "The factory trigger and sear are on the left and a custom hammer and sear on the right. The sear engagement with the hammer on the custom trigger/sear set is minimal but the angle of engagement is steeper giving a solid engagement. The safety leg of the sear is slightly longer than factory. If too long to engage the safety when the sear & hammer are in the full-cock condition, it must be shortened by stoning a very small amount from the leg at point A until it just clears the crossbolt." (Author Photos)

Random Notes from:
Prairie Wolf Gun Repair



by Marshall Smith
Owner/Gunsmith

April is Tax month

Taxes are due this year on the Friday, April 15th. Are you getting a refund this year? What do you plan to do with your refund? Go on a vacation? Buy some clothes? How about buying a new gun or accessories for your favorite carry gun. Or maybe just buy some ammo. If you decide to buy a new gun with your refund choose wisely. Check out the reviews online of any gun you are considering. Look up the blogs for that model or manufacturer of the gun. Does it have issues with quality, finish, shoot ability? Will it do the job you want it to do? You wouldn't buy a .22 to go bear hunting, would you? Does it have a reputation for being ammo picky? Just because a gun is pretty, or mean looking, or just the hottest thing on the market, doesn't mean it is a good gun. Do your homework and remember, Caveat Emptor, "Let the buyer beware". Sometimes you can get a good deal, most often not. If it is a used gun, have someone knowledgeable in that make and model or a gunsmith check it out before you buy.

Ruger 10/22 Trigger Notes

The Ruger 10/22 has been a popular .22 lr rimfire rifle since its introduction in 1964. Over five million

rifles in various models have been produced. It has been loved by many shooters, and I am one, but has one common complaint, the trigger really sucks. The trigger weight (pull weight) is 8+ Lbs. The trigger take up is very generous, the trigger pull is has a lot of creep before the sear releases the hammer, and the trigger is loose and flops from side to side. The safety when engaged blocks the sear and is of simple but stout design but easily defeated. Creep as mentioned earlier is when the trigger must be pulled over a noticeably long distance before the sear (which holds the hammer in full cock) clears the full cock notch of the hammer releasing it to strike the firing pin. A crisp trigger is one which the movement of the sear moving out of the full cock notch is very short so as to be unnoticeable, but, holds the hammer solidly with no chance of early or unintended release. The poor trigger action of the 10/22 and others similar trigger systems have generated a large market for gunsmiths like myself and after market custom trigger manufacturers alike. The market is capturing the shooter's dollars at an incredible rate. Drop-in custom trigger systems range from a high of \$275 to a low of \$120. Parts kits to reduce trigger pull range from a high of \$159 to \$60. A gunsmith doing custom trigger jobs may cost upwards to \$200. There are numerous videos on You Tube that show how to disassemble and grind the trigger and sear to lighten the pull weight. Of the videos I've reviewed all failed to address the most important factor in the lightening the trigger pull process. That's the safety. Important note here, if you decide to do your own trigger job on the 10/22, here's an absolute. DON'T GRIND, POLISH, OR CHAMFER THE SEAR. Better yet, just buy one of the drop in systems. That may change the looks of your rifle but your customizing it anyway.

In the case of the Ruger 10/22 the safety is a cross-bolt safety that blocks the sear movement and not the trigger. The sear moves anytime the trigger is pulled. The crossbolt sets at the tip (A) to block the sear from moving downward and releasing the hammer. With the stock trigger setup the sear sets very deep into the hammer's full cock notch. Ideally with the safety engaged the movement of the trigger and sear must be quickly blocked by the crossbolt safety. The Ruger sear piece has a leg extension that drips down to the safety cross-

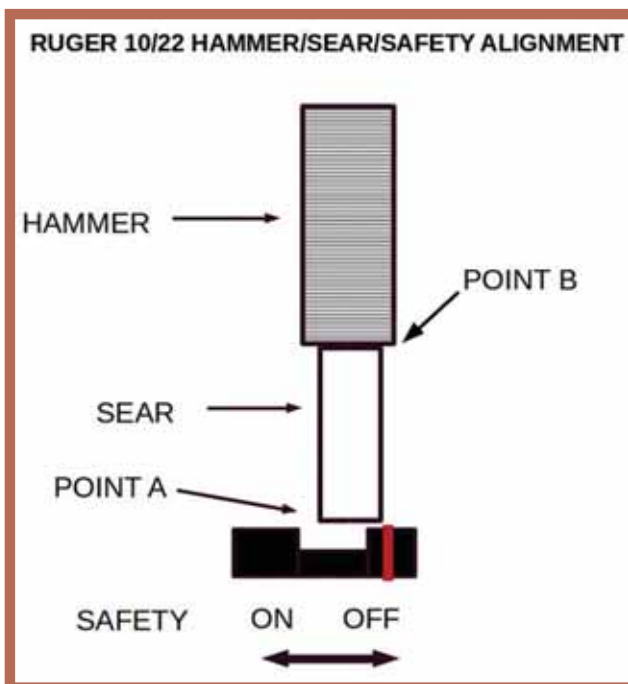

"I made this simple graphic to show how the sear when engaged in the full-cock notch of the hammer sets above the crossbolt safety in the ON position. There may be a small amount of gap between the crossbolt and the sear leg at Point A in the factory set up. With the large amount of seating engagement of the sear in the full-cock notch it isn't a major concern. However, when the hammer full-cock notch is filed down that small amount of gap at Point A becomes a major problem allowing the sear to pop out of the notch when the safety is pushed to the OFF position." (Author Drawing)

bolt. When safety is engaged the leg sets on top of the crossbolt stopping the sear at point A before the hammer is released. The gap between the safety and the sear's extension must be less than the distance the sear moves when the trigger is pulled to release the hammer. Therefore Ruger sets the sear engagement in deep in the



BUY SELL TRADE

Pistols / Handguns / Rifles / Shotguns

2213 S. Scatterfield Ste. #6, Anderson, IN 46016

Phone: 765-646-9000 / Fax: 765-646-9010

Hrs. MF 10am-6pm / Sat. 10am-5pm / Closed Sun.

FACE BOOK: [9-GUNS](#)

WEBSITE: www.9-guns.com

E-MAIL: contact@9-guns.com

HIGHSMITH GUNS

"INDOOR SHOOTING & ARCHERY"

Sales & Training

Indoor Shooting and Archery

Best Prices — New & Used

NRA Law Enforcement Instructors

Register for Classes Online

(317) 462-6290

123 N. State St., Greenfield • www.highsmithguns.com



Handguns, Rifle, Shotgun Repair, Cleaning & Inspections, Scope Mounting & Bore Sighting, Refinishing and Gunsmithing Services

You can ship your gun directly to PWGR. Call for shipping information. Local Pickup & Delivery of Your Gun Available

For Information or to Set an Appointment Call

765-914-2781

6151 Turner Road Richmond, IN 47374
PrairieWolfGuns@gmail.com

FFL 4-35-177-07-5C-04489

hammer full cock notch. The long movement of the sear makes for a heavy trigger pull and large amount of creep as the trigger must move the sear over a large area of the full cock notch before it releases the hammer. Reducing the trigger pull weight is not an easy fix as many You Tube videos might lead one to believe. Removing too much metal from the hammer and sear, or not keeping the sear and hammer faces square, or changing the angle of engagement between the hammer and sear can lead to an unsafe trigger and a failure of the safety to fully block the sear movement.

There are many reports of individuals doing their own trigger job on the 10/22 with the result being that when the safety is engaged and the trigger is pulled, a slight click is heard. Upon moving the safety to the fire position the rifle fires without pressing the trigger. That can be shocking and dangerous. There are ways to correct this but all require the sear safety leg be lengthened

or the hammer full cock notch be deepened. Work that should only be performed by a competent gunsmith.

The market has become so large that Ruger decided to join the after market crowd and now produces the black polymer BX drop-in trigger system that addresses the trigger and sear pull weight problem. It does make me wonder why Ruger just didn't make the changes in the manufacturing of the rifle. (*Do you have a problem with a trigger system being made of polymer and not steel? I do.*) I think the major concern with the rifle's trigger pull was to have the trigger sear engagement so deep that it would be impossible to bypass the safety when it was in the safe position. A good safety should do one of three things. It should disengage the trigger from contacting the sear, or, it should block the trigger from being moved at all (most crossbolt safeties), or, it should block the sear from moving out of engagement. There are some other unique safety designs on guns but they all do basically one or more of these I've mentioned. If you have a 10/22 that has a terrible trigger pull and want a better trigger, talk to a gunsmith about the options before you commit to changing your trigger.

Gun Safety and Training

Spring is upon us. Get out and shoot. Practice your shooting skills, practice self defense. Check your area for gun training ranges that teach self defense tactics, both hand to hand and gun tactics. Being a great gun fighter doesn't mean your going to win a fist fight or an attack from a ball bat or knife. Be aware of your surroundings. Train.

**Quote of the Month
THE CONSTITUTION**

They keep talking about drafting a Constitution for Iraq.... why don't we just give them ours? It was written by a lot of really smart guys, it has worked for over 200 years, and we're not using it anymore. - Larry the Cable Guy

That's all for this month. These notes are mine alone and do not represent the opinion or position of anyone, just me. If you have a question or a comment on guns,

gunsmithing, gun rights, or, would like to just make a comment email me with your comments at PrarieWolfGuns@gmail.com. I'll try and answer your questions as best I can and some answers may be included in this column.

Remember, B SAR (Be Safe, Be Aware, Be Responsible)

Marshall Smith
Owner/Gunsmith
Prarie Wolf Gun Repair

So You Wanna' Catch More Fish

CONTINUED FROM PAGE 5

DNR has a big parking lot next to the river in an area called Treaty line. This is a perfect spot to park the car and spend the day fishing. The river is easily accessible for everybody. The white bass is a schooling fish that are also running up this river to spawn. The wall-eye will be mixed right in with them. Fish for them using 1/16 ounce jig tipped with a minnow or night crawler. Fish it slow and close to the bottom. To catch white bass its just a simple cast and retrieve with a small white curly tail or a small in-line spinner.

Remember these places are rivers and are subject to flooding in the spring.

April showers bring May flowers.
Good luck Tag

If you need more info E-mail me at tag@tagnobbe.com or go to the web site www.brookvillelakeguideservice.com or call my cell phone 765-265-3238.

I guide fish for walleye, and crappie starting mid April till the mid December 7 days a week on Brookville Lake. We fish out of a 2015 Lund Pro V 2075 with a 250 Honda engine. I supply everything all the way down to cleaning the fish. I can take 1 - 4 people. The price is according to how many people go \$450.00 for 4 people \$375.00 for 3 people \$325.00 for 2 people and \$275.00 for 1 person. We start at 7:00 am and fish till 1:00 To schedule trips call or text me at home on my cell phone 765-265-3238

Fully licensed and insured for 19 years now.



WEEKDAYS 9-6 SATURDAY 9-12
(812) 752-5466
800-521-5344
www.candtcycles.net



15% OFF ALL ATV ACCESSORIES IN STOCK
10% OFF SPECIAL ORDERS
 We Service All Major Brands of ATV's
 From Oil Changes to Complete Rebuilds
 Hwy 31 S. in Scottsburg, IN. Just Off I-65
 30 Mife. N. of Louisville — 85 Miles S. of INDY.



Prepare for the muddy season
 Leave the Mess Outside

- SOLE SCRAPER can help keep your vehicle, house, patio, camper and business clean
- The blade cuts into mud and debris, and brush digs into the tread
- Made of steel and rubber, powder coated for long-lasting durability
- Outdoor model used for patios, campsites, business and home entries
- Hitch model available in multiple sizes, does not interfere with pull-behind
- Perfect for hunters, farmers, construction workers, gardeners, campers, outdoor sport enthusiasts and home and business owners



ADAPTABLE. DURABLE. SIMPLE.

Hitch Model \$39.99 + tax and shipping
Outdoor Model \$59.99 + tax and shipping

order today at www.solescraper.com
 or 317-750-0815

Like us on Facebook Follow @solescraper Sole Scrapper is Patent Pending

BUTLERVILLE GROCERY
 5185 E US Hwy 50
 Butlerville, IN 47223
 812-458-6355
 Deli • Gas • Grocery
 Hot Food • Daily Specials
 Military Discount
 Call In's Welcome
 Dine In • Carry Out
 Open 7 Days a Week

BURRIS ELECTRIC & PLUMBING SUPPLY, INC. SINCE 1980

COMPLETE LINE OF ELECTRIC & PLUMBING
 CUTLER-HAMMER • G.E. SW GEAR
 HYDROMATIC • BROAN
 TOLL FREE 1-800-998-3576

AUSTIN
 812-794-2257
 199 N. FRONTAGE RD.
 1-888-845-2388

MADISON
 812-273-2976
 2976 SHUN PIKE RD.
 1-877-322-7401

SEYMOUR
 812-522-7401
 110 N. O'BRIEN ST.

Visit Fayette County, IN For The Fun Of It!

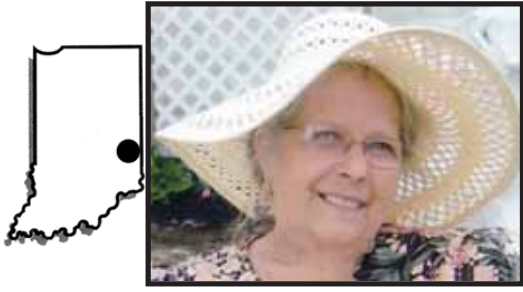

by Donna Schroeder

President of Fayette County Tourism Bureau

Spring has Sprung

We had a neighbor who always declared that Fayette County is the garden spot of America. I don't know if we could verify that, but I can testify that some of my most pleasant days have been spent in a garden. Looking ahead to the next few weeks, I would say that there are many others who share my enthusiasm.

I love flowers! I'm especially fond of perennials. They save you the trouble of replanting each spring. In addition, they can supply a nice surprise as a gardener ages. Each fall, I'm drawn to the bulb section at the garden store. I grab a bag or two of tulips or daffodils. When I get home, I try to remember where I've planted before and go to another part of the yard. The arrival of spring leaves me in awe, as I'm never quite certain where a clump of blossoms might appear. Every year, I contemplate making a chart, but I never do. I think my subconscious enjoys the surprise. Not only that, I avoid the disappointment of realizing that the squirrels have eaten bulbs that I might have expected to bloom. You don't miss what you don't remember you had.

When the tourism board asked local organizations to tell us what they were planning this spring, the response was immediate, and I was really excited to learn of all the garden and nature-related events. Not everything centers on gardening, but several upcoming events will.

The plant sales are always sold out events! They're my favorites because the growers are there to help customers decide what plants would do best in specific areas of the garden. Proceeds from the sales go back into the community through plantings in public places, scholarships, and local mission work.

I realize it's a little early to put some of the entries in this month's issue, but I thought some folks might like to mark their calendars. The April and May events offer the opportunity to visit some terrific places in my neck of the woods.

Many of them are happening at Roberts Park, one of the nicest facilities in the area. Colonel Roberts donated the land, and I think he would be proud of the way it progressed over the years. The Longwood Kennedy covered bridge was brought here from west of town several years ago after becoming too small for many of today's vehicles. It offers the chance to take a good look at the craftsmanship that went into these structures. The amphitheater and Roberts Building were WPA projects that helped many families weather the Great Depression through the jobs created. The Aquatic Center (a fancy name for the beautiful park pool) is

a great place to spend a warm summer day. The park is a local historic district, and the city deserves credit for taking such good care of it.

Bluegrass at the Roberts Building March 25th at 7 p.m. This is an ongoing presentation at the park. If you love this style of music, it would be a great opportunity to follow what this group is doing. The rehabilitated Roberts Building is a nice setting. Admission is \$10.00. Refreshments are available at reasonable prices.

Hunters' Education Class at the lodge in Manlove Park. All day, **March 26th**, beginning at 8 a.m. All ages. Call (765) 478-4080 for more info. If you've never visited Manlove Park, come and get acquainted with one of Fayette County's best kept secrets.

The **Easter Bunny Express** is right around the corner, **March 26, 2016**. The 16th annual running of the Easter Bunny Express will depart from Connersville Grand Central Station and make 4 round trips to the Easter Bunny Patch 2 miles away. Don't forget your Basket. Come and meet the Easter Bunny and hunt for his Golden Egg. The egg hunt is open to ages 8 and under. Reservations are recommended. Prices are \$10.00/person 2 and up. Train departs at 10am, 12pm, 2:30pm & 4:15pm. Train operates rain or shine. Tickets are available now via their online ticket window or by calling the depot at **765-825-2054**.

For the **Death of Tom April 1st and 2nd**. Meet and interrogate famous literary and historical characters as you help solve the mysterious murder of Tom Ripley at the FCPL. Food and Fun will fill the evening. 50 tickets available each night. For details, call the Fayette County Public Library at **(765) 827-0883**.

Fayette County Historical Museum will have its season opening on **April 10th**. The museum is open 1 p.m. until 4 p.m. on Sundays and Thursdays through early December. Connersville built horse drawn vehicles and automobiles are among the displays. Admission is free, but donations are gratefully accepted. The facility is manned by knowledgeable volunteers and supported by Historic Connersville, Incorporated through dues and donations. It's conveniently located at 103 Vine Street, at the junction of Highways 1 and 44 on the east side of Connersville. Visit Historic Connersville on Facebook **(765) 825-0946**

2016 Spring Festival at the Mary Gray Bird Sanctuary! **April 31st** Hikes, bird banding, and more! carl.wilms@indianaaudubon.org or visit Mary Gray Bird Sanctuary on **Facebook**. The Sanctuary is owned and operated by the Audubon Society. There are activities all summer, but you are always invited to hike, camp, and enjoy the scenery at any time! This was the home of the Gray family. Finly and Alice Green Gray donated the family farm in memory of their daughter Mary. It's a great place to enjoy nature. **Connersville High School Plant Sale May 6th and 7th** Friday, 3:40 til 6 p.m. and Saturday 9 a.m. til noon. Plants grown in the high school green house! Location: Connersville High School. The line always forms before the sale opens after school on Friday. The kids are enthusiastic about this project, and the plants are great quality. **Fayette Garden Club Annual Plant Sale at Roberts Park. May 7th** Park Road shelter. Annuals, perennials, herbs. 8 a.m. til sold out. **(765) 825-9775** **Central Christian Church Plant Sale May 7th** 9th St. and Central Ave.. 8 a.m. til noon. Annuals, perennials,

herbs **(765) 825-4146**

Mother's Day Valley Flyer - May 8, 2016 Whitewater Valley Railroad. See their website <http://www.whitewatervalleyrr.org/excursions/> or call **765-825-2054** for more details.

Fayette County Master Gardeners Spring Fling at Roberts Park in Connersville. **May 14th** Be sure to check out the great selection of vendors, plants, garden art, herbs. Hands on gardening demonstrations, activities for kids. 9 a.m. to 2 p.m.

The Whitewater Valley Arts Association will present exhibits **April thru June** at its gallery at 249 W. 28th Street in Connersville. You can visit their website www.wvartsa.com for more information on exhibits and activities.

The Fayette County Farmers Market is scheduled to open **May 21st** from 8:00am-11:00am at the courthouse parking lot. More details to follow, but what a great way to get fresh local produce! We're excited to see this begin at this location!

While you're in town, be sure to visit the **Canal House garden**. It's located across from the courthouse. The house is open during special events and for tours upon request, but the garden is accessible at all times. The centerpiece is a part of the original Clio Fountain and is made of brownstone. When it began to disintegrate, it was replaced with a reproduction that can be seen at the point where Central Avenue and Grand Avenue converge. Historic Connersville preserved a part of the original at the Canal House, **111 East 4th Street**. Canal House was built in 1842 as the headquarters for the Whitewater Canal.

The merchants and dining establishments also invite you to visit while you're in town. Check out the tourism website at tourconnersville.com or visit the Fayette County tourism page on Facebook. You can also reach us at **(765) 825-1523**. You're always welcome in Fabulous Fayette County. Hope to see you soon!

RUSTIC ACRES WOODWORKS

Rustic Post & Rail Products

Swings • Gliders • Lounges • Picnic Tables
Chairs • Night Stands • Beds • Log Home Railings
And Much, Much More!

David M. Fisher
765.886.5699

4600 New Garden Rd.
Williamsburg, IN
47393

Fayette County Welcomes YOU!

Visit the Fayette County Historical Museum
Opens April 10th Thursday and Sundays 1-4 p.m. thru Dec.
FABULOUS FAYETTE COUNTY WELCOMES YOU.
Visit Fayette County Tourism on Facebook

For information on more to see and do, visit:
<http://www.tourconnersville.com>
or call **(765) 825-1523**
Fayette County Tourism Bureau

BERTCH'S HARDWARE & RAMEY PLUMBING

HARDWARE
PAINT
PLUMBING
ELECTRIC

51 W. UNION ST. LIBERTY, IN 47353
PH: 765-458-5512

Cap N Hook Sports

"Your Geist Lake Connection"

- Fishing • Hunting • Live Bait
- Ammunition • Tasers • Muzzleloaders

"Introducing Archery!"

Tim Wolfe Wildlife

"Deer & Turkey Check Station"

OPEN YEAR ROUND

6383 West Broadway
McCordsville, IN 46055
(317) 336-HOOK (4665)



Attending the 1940-1963 Basketball Bash was many former Wayne County School basketball team members, 18 former cheer leaders, Committee members Senator Allen Paul, Jim Harlan, Duane Hodgkin, Stephanie Beaty and Mary Lou Griffey and invited guests. (This photo was made from 3 photos taken at 3 different angles)



Jim Harlan, Executive Director of the Wayne County Historical Museum (WCHM) and Committee Member welcoming everyone to the 1940 to 1963 Basketball Bash on Saturday February 6, 2016. Jim graduated from Richmond High School in 1966.



Basketball Bash Committee member Senator Allen Paul was instrumental in getting the ball rolling so to speak for the Basket Bash. Here he is thanking everyone for attending and telling the guests why he felt so strongly in helping put it together.



I didn't get a photo of Duane Hodgkin at the speaker's podium so I took this from part of another photo. Duane is a Board Member of the Richmond High School Alumni Association and a Committee member of the Basketball Bash.

Wayne County's 1940-1963 Basketball Bash February 6, 2016 by Ray Dickerson Centerville High School

I got involved with the Basketball Bash after I received an e-mail from Jim Resh on November 11th telling me about a meeting to be held at the Wayne County Historical Museum on Wednesday November 18th concerning putting together a Basketball Bash on February 6th, 2016 at the new reception room at the museum. So I accepted his invitation and after attending the event on February 6th was very happy I was there.

I need to let you know ahead of time before you get into reading this article due to a lack of time getting this prepared there are some gaps. If you

see something I have written that is wrong, like mis-spelled name or a name left out or just anything you see. If you let me know I will correct it in a later issue. See page 3 in this paper for my contact information, telephone, e-mail or website.

The reason for the Basketball Bash was to celebrate the one-class sectionals of the county teams from 1940-1963 inviting sectional players before the schools consolidated.

The Committee members invited former County Basketball players, managers, coaches, cheerleaders of the 12 former Wayne County schools that participated in the sectionals prior to those consolidations in 1963.

Attending the Basketball Bash were the Basketball team members from the towns of Boston – Terriers; Cambridge City – Wampus Cats - Blue & Red; Centerville – Bulldogs – Blue & White; Economy – Cardinals – Red & White; Fountain City – Little Giants; Greens Fork – Black Demons – Black & Gold; Hagerstown – Tigers – Purple & Gold; Milton – Sharpshooters –

Gold & Maroon; Richmond – Red Devils – Red & White; Webster – Pirates - Black & Orange ; Whitewater – Bears and Williamsburg – Yellow Jackets – Black & Yellow.

Basketball Committee members: Jim Harlan, WCHM Executive Director 962-5756 grad RHS 1966; Stephanie Beaty, WCHM Program Director 962-5756; Duane Hodgkin, RHSAA Board Member 317-696-9272; Senator Allen Paul, Historian 966-4032 and Mary Lou Griffey, RHSAA Executive Director 765-277-9359.

All the planning and meetings were held at the Wayne County Historical Museum located at 1150 North "A" Street in Richmond, Indiana. The scoured the area in search of school uniforms, programs, news paper articles, photos, etc. from 1940-1963. And I must say they did a terrific job. See pages 18 and 19 for photos of the memorabilia they were able to find. Editor's Note: This 4 page pull-out has an exception, I had to add a fifth page. So if you want to pull it out for a keepsake

CONTINUED ON PAGE 16

**A-1 LOCK
&
SAFE SHOP**

765-966-2597

Tri-County Awards

765-966-0757

SignGrafX

765-962-3636

1001 South "E" Street, Richmond, IN 47374

WESTSIDE STORAGE

Commercial Residential

Open 7 Days A Week

All Drive Up Units

(765) 962-5778

www.wsrichmond.com

Local Owners on Site

401 Porterfield Ave., Richmond, IN 47374

OFFICE 900 FEET

WESTSIDE STORAGE

↑
WATCH FOR SIGN

**ELECT
LARRY FOUCHE
COMMISSIONER**

"FORMER WEBSTER PIRATE"
MAY 3, 2016



(Names may not necessarily be in order) Left Photo (L to R) Cheer Leaders before school consolidation: Doris Bockhofer Phelps Fountain City 1952; Loretta Delucio Fountain City 1958; Pat Corder Shank Fountain City 1950-51; Loraine Delucio Stallings Fountain City 1957; Becky Cranor Greens Fork 1962; Sandra Armacost Hodgkin Richmond 1963; Joanna Mikesel Ingerman Fountain City 1952; Marsha Duffin Powell Milton 1963; Mary Ann Resh Carp Centerville 1957; Deloris Bane George Greens Fork 1962; Cheryl Johnson Haynes Webster 1962; Bonnie Godsey McClain Richmond 1960; Carolyn Kennedy Judy Fountain City 1961; Carolyn Eliason Gardner Centerville 1960; Sherrie Fawcett Fulton Centerville 1960; Barbara Toschlog Hieger Whitewater 1959 and Jim Resh Centerville 1958.
 Right Photo: Last Wayne County basketball team member attending the festivities to officially sign the official Basketball Bash Basketball.



A Jump Ball (Let's get started) scenario between from left to right Duane Hodgkin with hand raised, Jim Keifer, Allen Paul holding the ball and Cliff Dickman with his hand held high ready to tip the ball.

At left Referee Duane Hodgkin officiating the Free Throw Contest with basketball team players tossing a small basketball into a basket with a lady and young girl waiting for one of the shooters to make a basket. This was a lucky camera shot suspending the ball in mid-air.

CONTINUED FROM PAGE 15

be sure to tear out page 19 also.
 I arrived at the Wayne County Historical Museum Reception room just a wee bit early, as did everyone else. We were given a certificate that read, "Wayne County Sectional Basketball 1940 to 1963 The Glory Days. This Certificate recognizes Ray Dickerson Class of 1959 As a Centerville Bull Dog During The Sectional Glory Years. Presented by The Wayne County Historical Museum and The Richmond High School Alumni Association. Honored on February 6, 2016.
 At the door I met Harold Routson and Denny Jones, for some unknown reason we stood at the door holding it open for people going inside while we reminisced about the by gone days.
 We finally went inside to sign in and then proceeded to find our table, 7. On table 7 at each persons chair was a sheet entitled: The Wayne County



Banners representing the Wayne County basketball years before consolidation, 1940's, 1950's and 1960's.

A - T & I SERVICE

<ul style="list-style-type: none"> • Country Clipper • Honda • Team Stihl 	<p>For all your Agriculture, Lawn & Garden Automotive, Aluminum & Steel Trailer and Service or Parts needs</p> <p>1414 Wise Road, Cambridge City, IN 47327 PH: 765-478-5917 Website: www.atiservice.com E-mail: sales@atiservice.com</p>	<ul style="list-style-type: none"> • Featherlite Trailers • Diamond C Trailers • Custom Made Hydraulic Lines
--	---	---

BEST PAWN

BUY • SELL • TRADE
GUN TRANSFERS

- CASH LOANS
- GOLD & SILVER
- HANDGUNS • FIREARMS
- CARS • TRUCKS
- HEAVY EQUIPMENT • TRAILERS

Call Us:
765-939-PAWN (7296)

Hours: Mon-Sat
10 am - 7 pm
Closed Sunday

1700 N.W. 5TH ST.
RICHMOND, IN 47374

WEBSITE: www.bestpawnindiana.com

CABINET FACTORIES OUTLET OF RICHMOND

SEE US FOR:

- Cabinets By Schrock • Countertops (Granite & Formica) • Sinks & Vanities

Visit our Discount Room - All Cabinets \$69.00 or less / Free Estimates / We Deliver
633 South H Street, Richmond, IN 47374 - 765-966-3875

Hrs: T-F 8 am-5 pm / Sat 8 am-12 pm / Closed Sun & Mon - Website: cabinetoutletofrichmond.com



I have this lady's name on my tape recorder, but couldn't find it. This ball was signed by all the county basketball team members who attended.



The Webster Pirates won The Game refereed by Duane Hodgkin and Jim Keifer. The winning members present from left to right. Duane Hodgkin at left hands Jerry Wright the Basketball Bash Trophy. Webster Pirates team members from left to right Front row: Jerry Wright, Bob Plankenhorn and Cliff Dickman. Back Row: Bill Cox, Jim Cox, Larry Fouche and Troy Smith.



Janis Buhl, owner of the Western Wayne News and a Wayne County graduate from Cambridge City High School.



Table 7 representing the Centerville Bull Dogs from left to right in front row Cheer Leaders Jim Resh, Mary Ann Resh Carp, Carolyn Eliason Gardner and Sherrie Fawcett Fulton. In the back row: Team members Denny Jones, Harold Ralston and Jim Howell. Far right Ray Dickerson, Centerville graduate and The Gad-a-bout.

Hysterical Sectional Basketball Program 12 pm to 3 pm Sat. Feb. 6, 2016.

The National Anthem & Welcome - Announcer and AD Jim Harlan. The Sectional Drawing (Order to the Banquet Line) Head Cheerleader Stephanie Beaty. Concessions; (Ticket Draw) Team Manager Allen Paul. Try Outs (Trivia Contest back side of this sheet) Official Score Keeper Mary Lou Griffey. The Game Referees Duane Hodgkin and Jim Keifer, Jump Ball (Let's get started) Free Throw Contest; Time Outs (Memories Shared) Trophy Presentation/ MVP; Post Game Celebration (Public time Out) (We are not responsible for excessive fun)

I wasn't aware of the significance of this document and left it lie. I did try to answer the trivia questions when Carolyn Garner said something about it. All day long the 12 different Wayne County High School team members

CONTINUED ON PAGE 19



Waiting in line I snapped this photo of a few of the attending Wayne County high school basketball team members, wives and invited guests. The food was excellent, one of the few times this writer has gotten to eat when getting a story. I had a newspaper waiting on me at home to finish, but it had to wait.

WE BUY GOLD

Paying Top \$ For Scrap Gold & Silver

Do you have any broken jewelry or old jewelry you just don't wear anymore?
We'll Turn It Into Cash Today!

Jensen's Pawn Shop
702 S. State, Greenfield, IN
7 Blocks South of the Courthouse
462-4721

Immediate Cash
Loans on Secured Merchandise

Buying & Selling
Gold & Diamonds, Tools
Electronics & More

We Value Your Trust and Confidence

405 E. Main St.
Centerville, IN
855-5342

Mills Funeral Home
www.doanmillsfuneralhome.com

WILDFIRE MOTORS
BAD CREDIT, NO CREDIT, NO PROBLEM

CARS ~ TRUCKS ~ SUV'S
4741 National Rd West (Corner of US 40 & Airport Rd) Richmond, IN 47374
CALL: 765-939-FIRE (3473)
E-mail: wildfiremotors1@gmail.com / Website: wildfirerichmond.com

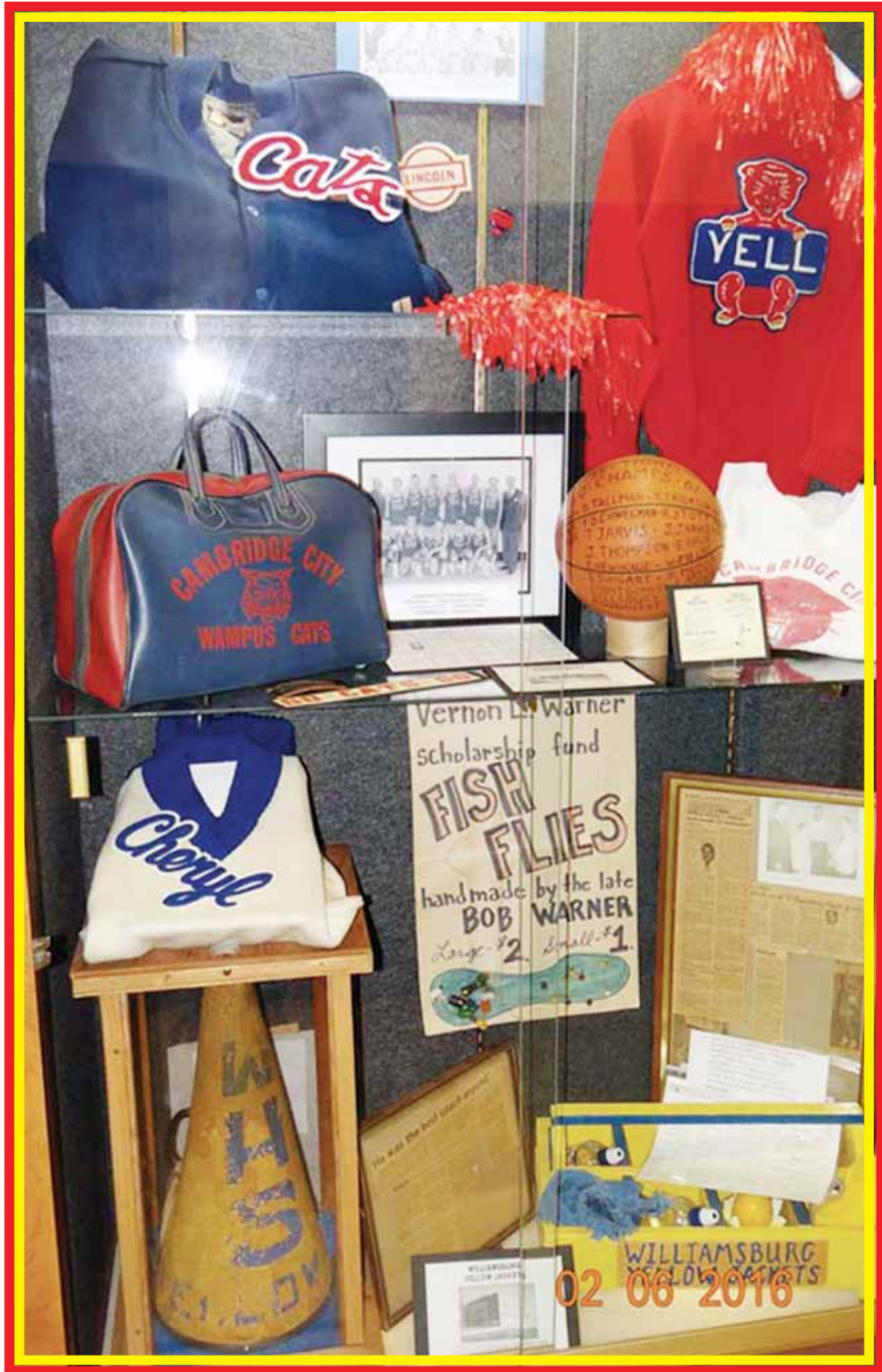

Memorabilia collected for I believe the Cambridge City Wampus Cats and the Williamsburg Yellow Jackets. You will note a red and yellow border around the photo for these two teams.



Memorabilia collected for I believe the Centerville Bull Dogs and Richmond Red Devils. You will note a blue and red border around the photo for these two teams.



This banner for the Milton Sharpshooters was hanging on the wall in the Wayne County Historical Museum.

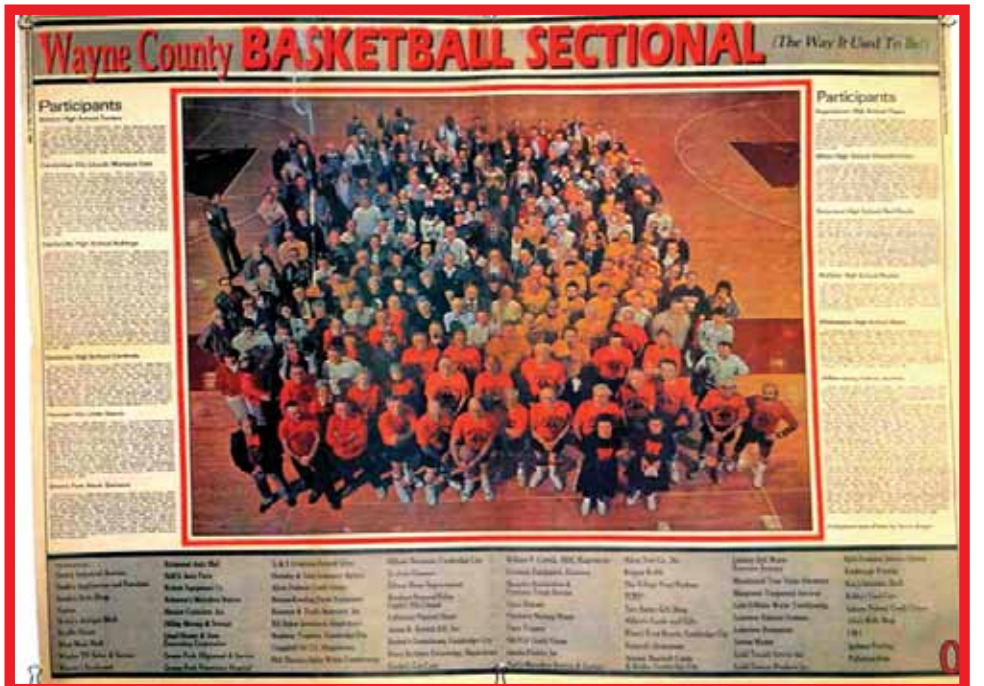

This Wayne County Basketball Sectional page out of an unknown newspaper was hanging on the wall in the Wayne County Historical Museum.

Matt's Custom Guns
 Hours: Monday - Friday 9 am - 5 pm (Other hours by appointment)

Guns - Ammunition - Scopes - Accessories
 Custom Target & Hunting Rifles - Specialize in Reloading Supplies
 Gunsmithing - Muzzleloading Guns & Supplies

Authorized Dealer for Freedom Arms, Dakota Arms, Nesika, Kimber, HS Precision & Dillon Precision
 3762 N CR 450 E, Connersville, IN 47331
 Ph: 765-825-3418
 Email: mattscustomguns@yahoo.com

Woodruff's Supermarket
 10 South Main St., Liberty, IN
 Full Service Meat Department
 Produce, Dairy, Groceries & General Merchandise
 Hrs: Monday - Saturday 6 am - 9 pm / Sunday 6 am - 7 pm
 BAKERY - DELI - IN STORE PHARMACY
 Donuts, Cakes, Cookies, Pies, & Rotisserie Chicken
 "Get Everything You Need At One Handy Location"
 Call Us At 765-458-6213
 www.woodruffsupermarket.com



Memorabilia collected for I believe the Milton Sharpshooters. You will note a maroon and gold border around the photo for Milton.



Memorabilia collected for I believe for the Webster Pirates, Economy Cardinals and Boston Terriers. I only used the Black and Orange colors for the frame around this photo for Webster, don't know the colors for other two.

CONTINUED FROM PAGE 17

were in the contest to see who could win the most by the end of the festivities. As it turned out the Webster Pirates won, see photo of their receiving the trophy on page 17. Their photo is also on the cover of this issue. Larry Fouche had a hand in that. Personally I had a lot of fun at the Basketball Bash. I personally want to thank Jim Resh and Mary Lou Griffey for the invitation and helping me with information for this article.

While reading this and enjoying the photos I have to beg your forgiveness I did not take photos of the different county schools. The only photos I was able to take was the Webster Pirates and Centerville. However for only \$15 you can purchase dvd of the entire event.

Here is the information you need to know to buy your own copy of the Basketball Bash,

February 6, 2016.

Dear Fan of the Wayne County Historical Basketball Sectional from 1940-1963. We had a "ball" at the gathering at the Wayne County Historical Museum on Saturday, February 6th. We made a DVD of the day's events, the historical displays of all the twelve high schools and the Power Point display. The Power Point has the picture of all the high schools, the mascots, the school colors and the school fight song lyrics. If you would like a copy of this one-of-a-kind DVD? We are making a limited number for sale. If you would like a copy mailed to you for \$15.00, please order yours today. Contact Mary Lou Griffey, Executive Director of the RHS Alumni Association by calling 765-277-9359 or Call the Richmond Alumni Association located in the Richmond High

School at 380 Hub Etichson Parkway, Richmond, IN 47374. Their phone number is 765-973-3338. If you have any questions call and leave a message, they will return a call to you. The RHS Alumni Association is a 501 (c) 3 non profit and your donation is tax deductible. Tell them you read about the DVD in The Gad-a-bout.

You can order one of the DVD's by mail, send a check for \$15.00 addressed to the RHS Alumni Association (address above) and they will send your DVD by return mail. Make checks out to RHS Alumni Association. They do accept a credit card purchase, give them a call.



ACE Scotts Hardware
 Junction 31 & 56, Scottsburg, IN
 812-752-2991

- WE CARRY A FULL LINE OF RIFLES, SHOTGUNS, HANDGUNS & AR'S
- OUR SHELVES ARE FULL OF AMMO, OPTICS & ACCESSORIES
- WE HAVE EVERYTHING FOR YOUR HUNTING, FISHING & SHOOTING NEEDS
- NOW BUYING GINSENG & YELLOW ROOT

Hours: 7 AM - 8 PM MON. - SAT. / 8 AM - 6 PM SUN.

Pioneer Village

Ethanol-Free Gas Live Bait

Firewood Hot Food

Bio-Diesel Propane

Fishing License and Lots More

Jct of Hwy 256 & Hardy Lake Road
 812-794-2769

NEW & USED PARTS FOR CRAWLERS TRACTORS BACKHOES, EXCAVATORS & SKID STEERS

Engine Kits...Injection Pumps...Hyds
 Tires & Wheels...Drive Trains...Front Axle

Mon - Fri 8:00 am to 5:00 pm
www.worleytractor.com

Worley Farm Salvage
 812-883-4313 / 800-854-4313
 Campbellsburg, IN

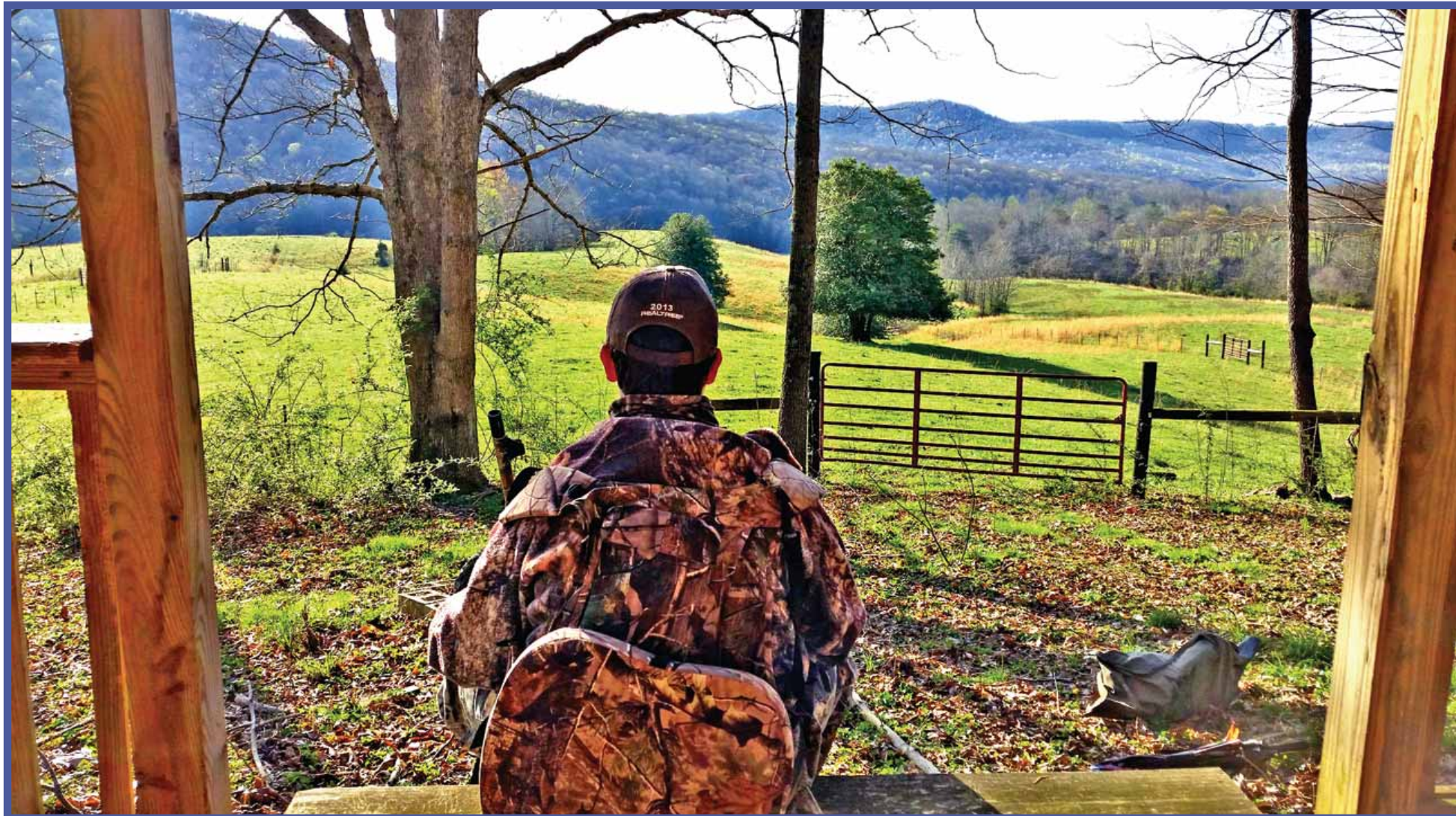

Nicholas Martino takes in the view from atop a mountain while turkey hunting in Tennessee last spring, before the Indiana season opened. (Author Photo)

Indiana Outdoors



by Joe Martino

Lengthening your spring turkey season is easier than you think Neighboring states offer opportunities

Turkey season; It's just not long enough. If you love turkey hunting and find yourself wishing you could do more of it; you can. Here in north-central Indiana, our spring turkey season is only open for two-and-half weeks, and that is simply not enough for me. Our paltry two-week season with a bag limit of one bird just doesn't do it for me. I enjoy turkey hunting too much to only spend a couple of weeks out of the year doing it.

Luckily I found a remedy for my turkey hunting

addiction; hunting in multiple states. It's easier than you think, and well within your reach, unlike a lot of big game hunts.

Case in point; I did some research when I initially began planning my first out-of-state turkey hunts. Missouri, for instance, has a spring season that pretty much overlaps with ours outside of a few days in the beginning or on the end, and tags are pricey at \$190 for one bird. Illinois is not much different and you must be drawn for a spring turkey permit, which cost \$125 apiece. These are good bets for taking your child on a youth hunt, however. Dirt-cheap licenses and earlier youth seasons make them hard to beat.

Kentucky is a bargain at \$60 for the license and the opportunity to kill two gobblers, but here again, not a whole lot of opportunity to extend your season here. Their season does open a few days ahead of ours, but not a lot. As for the absolute best turkey hunting and being a bargain; you simply cannot beat Kentucky. Something to remember if you tag early out in Indiana.

Then I noticed Tennessee and Michigan. Tennessee's spring turkey season begins around April 1st. Their licenses can be pricey at about \$275, but you can kill up to four gobblers for that price. My son and I took advantage of Tennessee's southern hospitality on turkey tags a few years ago during spring break. We went as a family with a simple plan. My son and I would hunt in the mornings and by the time we returned to our cabin, my wife would be up and ready to do family things the rest of the day. Our plan could not have gone any more perfectly. On the very first morning of our hunt, my son Nicholas, ten years old at

the time, smashed his very first southern longbeard.

What makes Michigan great is that their season does not go out until May 31st, which is pretty unique in these parts. I can also be at the state line in less than two hours. It also means that I can hunt spring longbeards for nearly three weeks longer than I can in Indiana, whenever time permits. And at \$69 for a permit, it doesn't break the bank either. So, even if I only

Martino's *Inside Dining or Carry-Outs*
 = *Italian Villa*
 Restaurant & Lounge

"Homemade Goodness In Every Bite"

Real Italian Pizza • Full Menu

- LASAGNA
- PIZZA
- STEAK
- SPAGHETTI
- SANDWICHES
- SEAFOOD

11AM - 10PM MON - THURS 11AM - 11PM FRI & SAT

765-457-9181

1929 N. WASHINGTON • KOKOMO, IN

COUNTRY MART

Garden Seed Season is here. Stop in today for all your garden needs.

Now stocking Organic Chicken feed.

Stop in today and let our friendly staff load your vehicle.

Premier Ag Country Mart Store:
 766 W. Main St. Greensburg, IN.
 Manager: Marvin Goodpaster
 (812) 663-6411

Joe's
 All Natural Beef Jerky

Joe Martino
 Direct: 765-434-8598
 E-mail: joe@eatjoesjerky.com / Web: www.eatjoesjerky.com
 2378 West 350 North, Kokomo, IN 46901



The first place I pulled into had a truck in the lot, but I didn't know where the hunter was – until I heard a shot a little ways into the section. I got back in my truck and drove to another spot where I did manage to strike a gobbler. The only problem was that bird was a half-mile away and never did close the distance. So, back to the truck I went, and as I was tooling down a gravel road, I saw a field strutter with a couple of hens. A quick check of the map proved the birds were still on public land so I pulled over the hill, snuck out of the truck, grabbed my gear and crawled a couple of hundred yards along the edge of the timber to try to get in the best position I could.

I got as close to the birds as I felt I could, but a hill in the field kept me from being able to lay eyes on

them. After an hour-long game of cat and mouse with me calling and the gobbler sometimes responding, I decided to rise up just a bit to try to catch a glimpse of the birds. As luck would have it, just as I rose up, I saw his bright red head pop up over the hill a mere twenty yards away. As quickly as he had appeared, he disappeared. Still, a pretty successful first-ever Michigan turkey hunt in my mind. I beat that bird. The only problem is that I also beat myself by getting perhaps a bit too anxious. Just a few minutes likely would have changed the outcome considerably, but how was I supposed to know?

So, if you love turkey hunting as much as I do and just cannot get enough of it, consider your options across state lines.

Nicholas Martino takes in the view from atop a mountain while make it to Michigan for a day or two each spring, it's worth it to me.

My first Michigan hunt started with me leaving my house at 3:15 in the morning and driving to a public hunting area that I had never set foot on. Sounds a little crazy, but what did I have to lose? Our season had already ended, so at the very least I was going to take in some nice scenery.

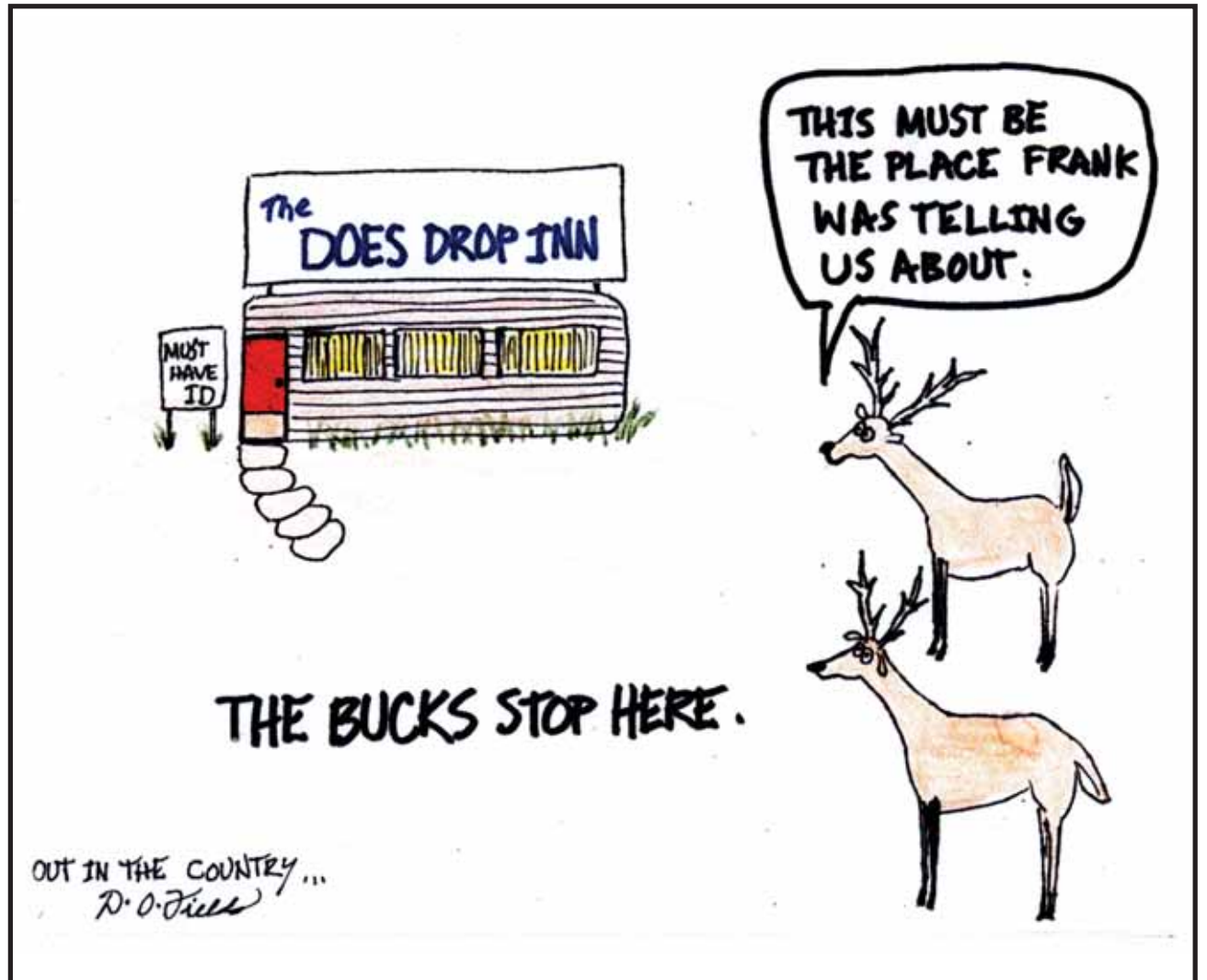

Richmond's Complete Home Improvement & Richmond's Overhead Door Co.

SIDING PATIO COVER ENCLOSURE
 FENCING WINDOWS GARAGE DOORS

Turn Your House into the Home that You Love

3920 NATIONAL RD. W. • RICHMOND
 765-966-6651 | 800-922-6651

"ACROSS FROM COURTHOUSE"

HOURS:
 Tues - Sat 6 am to 1 pm
 Sundays 6 am to 1 pm

Home Cooked Meals
 Dine-In or Carry-Out

LIBERTY RESTAURANT
 7 West Union St., Liberty, IN 47353
 765-458-5223

VISA MasterCard

ARMY NAVY

BACKPACKS CLOTHES
 ARMY NAVY
 GLOVES-WOOL-BLANKETS-PINS-PATCHES-BOOKS-BELTS-KNIVES-INCENSE-AND LOTS MORE

War souvenirs
 See Miles or Sharrie
 612 North A Street, Richmond, IN 47374
 Bus. (765) 966-0417
 1-800-686-2769
hhq313arty@frontier.com

Best STOP Auto Care 2 Salisbury Rd., Richmond, IN

Complete Auto Service

"Work at a price thats fair from people who care"

- Tune-ups
- Brakes
- Transmissions
- Major engine work
- Cooling system service
- Towing

Courteous, Friendly Service
 Questions? Just Ask! We're Here To Help!
 Pick up & delivery service available

CALL US TODAY
765-935-3849

VISA MasterCard ASE

KOKOMO MARINE SALES & SERVICE

MERCURY MerCruiser **LOWE BOATS** **MERCURY Outboards**

36 YEARS OF MERCURY MARINE SERVICE
 Mercury / Mercruiser Master Technicians

- Spring Tune-ups
- Storage

2000 North Phillips - Kokomo, IN
 (765) 457-2202



Black Kite (Milvus migrans) (Photo Courtesy of Wikipedia)



Brown Falcon (Falco berigora) (Photo Courtesy of Wikipedia)

Outdoors



With Rich Creason

Australian Raptors are Arsonists

Smokey the Bear would not like these birds! The black kite (Milvus migrans) and the brown falcon (Falco berigora) have both been reported as intentionally starting fires in Australia. Humans were long thought to be the only species which used fire as a tool, but it now looks like we are not alone. In fact, were we even the first, or did another species teach man how to use fire to our benefit?

These two medium size raptors (birds of prey) have been reported on numerous occasions carrying smoldering or burning twigs which have been picked up from an existing wildfire and dropped into a grassy area several hundred yards away. Australian firefighters often wondered how a relatively small fire could jump fire lines and start again somewhere else. But recently, these firefighters, park rangers, and local people connected to wildfires in some way have noticed this strange occurrence.

Natives of the area (aborigines) have used this fire carrying bird in their ceremonies for many generations. They even have a name for this sacred event. It is called "Yabadurrwa". Participants in this ceremony dress as birds and move flaming or smoldering sticks around the area mimicking birds starting fires. Why would they do this if they hadn't seen it happen?

It is common knowledge many birds fly around the edges of wildfires to attack other critters which are chased out of their homes by a fire. Small mammals, lizards, snakes, and many insects become easy prey when trying to escape the heat and smoke. Of course, canines and other land based predators also patrol the area looking for an easy meal.

But, so far, the kite and falcon are the only species known to actually start a fire in an area of their choosing. Their primary hunting area is grasslands or savannahs and sometimes agricultural areas. Wooded areas do not supply the variety of small species which are high on the menu of these birds. So, they pick up sticks from an already established fire and drop it in a nearby grassy opening where prey is more plentiful.

These two flying firebombers are not rare birds. Both are common in Australia, while the kite is also easily found in Africa, Asia, and Europe. Like most raptors, the falcon is usually found solitary or in pairs, but the kite hunts in large groups, sometimes in hundreds or even thousands of birds.

The brown falcon is about 16-20 inches long. It breeds from June to November. (In the southern hemisphere, winter and summer are opposite of ours.) They lay two to five eggs with red and brown spots. Their nest is usually one taken over from another hawk or raptor. The black (or brown) kite is about the same size, has the same food sources, but only lays 1-3 eggs. Both birds seem to have heavy skin, almost like an armor, on their feet and legs, probably to prevent snake bites. (Maybe to keep from getting burned!)

How did these raptors learn to carry fire, while most animals are thought to fear it? Obviously, some step in evolution occurred to assist the birds when food was scarce. How long ago did that first brave bird carry a flaming stick to his favorite hunting grounds? And, how many raptors flew flaming through the sky before they learned to do it properly?

Since this trick has been going on for many years, it is obvious the parents have taught their offspring how to use fire as a tool. Will other species learn this dangerous practice? Surely other birds are watching when this happens. Will they just continue to let the kite and falcon start the fire while they hang on the outskirts and pick up food as it comes racing out, or will they say "I can do that too!"? While no video has been taken yet of this fire starting practice, it is widely known in Australia that it does happen.

Coyotes, dingoes, wolves, and other canines are smart animals. How long before they learn to carry fire sticks? We seem to have a lot of wildfires in our western states. Has some animal species already read on the Internet how to flush food out of the forest or grassland? Maybe some of our fires aren't

started only by people or lightning as commonly thought.

Birds aren't the only species who have learned new ways to secure food. Any big game hunter who spends much time in our western states knows that when hunting deer or elk, the gunshot will possibly bring a large bear running toward the hunter. The bear knows the gunshot means "dinner". Dolphins, parrots, and crows have been observed using items in their habitat as "tools". Otters swim on their backs, place a clam or oyster on their stomach and break it open with a rock. This is definitely using a tool.

Bob Gosford, an Australian lawyer who represents aboriginal people has been studying these two raptors for years, and presenting his findings at scientific conferences. Steve Debus, a predatory bird expert from the University of Maryland has also reported the black kites have been seen picking up crumbs from picnic tables, then dropping them in ponds to attract baitfish which they then feed on.

So far, these Australian birds can only use established fire to start another fire. In a few hundred years, will they learn how to rub two sticks together to start their own blaze anywhere they want? Time will tell.

The author may be reached at eyewrite4u@aol.com.

Marion's Greenhouse
 4 miles North of 256 on Hwy 3, Deputy, Indiana
812-866-2856/701-2240
Mon-Sat 8:00 am-5:00 pm
BLOOMING PANSIES
BULK GARDEN SEED
ONION SETS
SEED POTATOES
VEGETABLE PLANTS
ANNUALS & PERENNIALS
HERBS
BERRY BUSHES
FERTILIZER - SOIL - MULCH

LOG HOME CENTER

Local distributor of

Located 4 miles East of Noblesville on Rt. 38
 773-3268 or Toll Free 1-800-773-6223

Gittin Jiggy With It
Bait & Tackle Store

765-524-6484

Why shop here?? Why shop anywhere else! We love fishing as much as you do!
 New Stock coming for Spring! Names like Okuma, Zebco, Lews, Fenwick, Berkley, Diawa and Jimmy Houston Signature Series, to mention a few!

We are Expanding our Cat and Carp Line of Products!

Like us on [FACEBOOK Gittinjiggywithitbaitandtackle](https://www.facebook.com/Gittinjiggywithitbaitandtackle) for news on arrivals

Open 7 days a week
4277 E SR 36 (Corner of 36 & Messick Rd) • Mooreland, IN 47360

Indiana State Trappers Association



by Dr. Fred Philips, DVM

End of the Line, What's next?

No one has died, though some trapping publications use this phrase to indicate the beginning of an obituary. I am just intoning that the 2015 – 2016 Trapping season is over, and everyone is now making the final preparation for the disposition of their furs. This is a year for thinking out of the box if you have any furs left as the Beaver / Otter seasons come to their close March 15th, 2016. Self tanning or professional tanning is a good way to end up with a nice skin that may be held and sold anytime into the future. Using your fur for crafts and clothing is another way to go. Finally, donating your fur to a Not-For-Profit Association, like the ISTA, gets you a donation in kind write off for your taxes, if you use a long form that is. Hopefully next year will be better, as it cannot get much worse than it was this year. If you would, send your "End of the Line" picture and your "Big Beaver" picture to the Gad-A-Bout. Ray will get them printed right along side of those big buck pictures.

As of Monday, Feb. 29th @ 3 pm the Otter count stands at 587. There are two more weeks for trappers in specific counties to collect 13 more Otter before their season closes. I don't know about you, but I think our IDNR did a fantastic job

predicting the right number to settle on. If you are not aware, Indiana's Fur Bearer Biologist, Shawn Rossler has left the employ of Indiana and moved back closer to home in Wisconsin. So once again Indiana is without a Fur Bearer Biologists, just as the two (2) year rule review begins again this year. Within a few weeks, you will be able to make comments on what you would like to see changed in the IDNR rules, on the IDNR website. Things like removing the 10 year old limitation on catching Otters is one I would like to see removed. The regular license is not limited, so why place the 10 year old limit except to try to head off families abusing it. Obviously the abuse has not occurred, or if it did, it is one or two families that will never play by the rules anyway, and probably don't belong to a single outdoor organization.

Another rule that I would like to see occur, is to allow limited trapping for Bobcats south of Hwy 70. I am told, by many trappers, that plenty exist, because they keep letting them out of traps. With the Otter season this year, it will be interesting to see how many Otter are killed on the road this year as compared to last year. Likewise, with the lack of a Bobcat season, it will be interesting to see how many Bobcats were killed on the roads last year, compared to this year. This number is one of the indicators of how high and healthy a population of wildlife is.

Trapper Education Classes are beginning to get scheduled. Bloomington TE is moving back to August. Carthage TE is planned for May 7 & 8. Kokomo TE is up in the air due to a change of ownership of the venue. Danville TE is planned for August 27 & 28. Laporte and Rockville TE will both be on Nov. 5 & 6. I saw where the FTA 7b was planning on having a TE on April 2nd at the Hoosier Trappers Supply, in Greenwood, IN. That is all that I am aware of at this time. There may be more coming, but they do not always communicate them to me. Be sure to watch www.PassItOnIndiana.org.

Remember to save the date for this year's ISTA 55th Annual Convention and Rendezvous to be held at Mill Pond Park, 100 Mill Pond Rd., Union Mills, IN. This is always a good place to have a convention and the FTA Fur Trapper College will be ending that Saturday. Who knows who may

just drop in to say "Hello". Watch the Website and the Newsletters for more information as it develops. Of course to get the newsletters, you need to be a member. Print out a form from on-line, or contact me at fpp@juno.com or 765.938.1806 (and leave a clear message) and I will send you one.

This past weekend, several new members signed up at the Deer and Turkey Expo at the fairgrounds. Look for the ISTA at these sort of events, or better yet, when you know an event is coming, contact a member of the Board to arrange to have a table at the event. If YOU will help us staff the table, we can supply all sorts of materials. We need you to help us get it started.

Finally, we have a couple of Raffles going. The NTA Gun of the 2015 Year, a Ruger .223 is closing on being done. There are only 250 tickets being sold at \$10 a ticket, or three (3) tickets for \$25. Stu Grell has these tickets at this time. We also have the Gun Give-A-Way, that will be drawn in September at our Convention. The first prize is a Taurus .410 / 45 Long Colt, five (5) shot revolver, deer legal RIFLE. Second prize is a laminated stock, .22 single shot, Cricket rifle. This rifle is so short and cute that you could almost put it in your back pocket to carry while out on the line, almost, but not really. To acquire tickets for either of these raffles, just get in contact with any Board member found on the website and let them know your interest.

2016 is going to be a great year!

Watch your top knot. Keep your eyes along the skyline.

Fred "DR" Philips, DVM
Pres. ISTA

Roaming The Outdoors

CONTINUED FROM PAGE 4

to help us by doing an article about it. I will provide the pictures and information for you. If it's possible, could we have something similar to the article about the Gem Show? I'm attaching a picture of the Mobile unit for you to see what the mobile unit looks like. Let me know if you have room in the August or September issues for the article and pictures.

Thanks for all you do for the veterans.
Rhonda Alvey

Brookville Lake & Whitewater Memorial State Park
E-mail: ralvey@dnr.in.gov

Phone: (765)-647-2657 ext 219

Mailing address: P.O. Box 100, Brookville, IN 47012

To see what is happening at our State Park, visit: <http://www.in.gov/dnr/parklake/2420.htm>
Like us on Facebook!

CONTINUED ON PAGE 25

Dale Hardy Supplies
Just 2 Miles North of US 24 on US 35
Logansport, Indiana
(574) 753-6843



- Houndsmen Dog Boxes • Cajun Lights
- Nite Lites • Hunting & Trapping Supplies
- Diamond Dog Food
- Red Wing Shoes • Carhartts
- Horse Supplies & Tack • Custom Leather

Carhartt Monday - Friday 9-6
Saturday 9-5
Closed Sunday
Hard at work since 1889.
dalehardy_supplies@hotmail.com

providing quality used auto parts for 27 years



Underwood Auto Parts

local 812-752-2226
fax 812-752-6308
TOLL FREE 1-800-628-7858

Hours: Mon-Fri 8am-5pm

One of Midwest's cleanest salvage yards!
ASK ABOUT OUR PROMPT DELIVERY SERVICE
www.underwoodautoparts.com
Find our store on eBay: underwoodautoparts
SAVE 20% WITH THIS AD / limit 1 per order



ANIMAL HOSPITAL OF CENTERVILLE

DR. FRED PHILIPS

1100 EAST MAIN STREET
CENTERVILLE, IN 47330

TELEPHONE: (765) 855-1450
TOLL FREE: 1-888-860-8253



EMERGENCY SERVICES AVAILABLE

TRAPS & MORE



Easy Transfer Roll Cage
19/73 Sliding Door



Squirrel Assit
Skinner



Fish Basket



Traps 12/12/36

DEALERS
See Their Advertisement in The Gad-a-bout
John's Gun & Tackle, Red Barn Bait Shop, Scott's
Ace Hardware & Tolliver's Hunting & Fishing

Ernest McCleery, Lexington, IN (812-866-4510)



Inside the Kuhlman Center was a beehive of activity as you can see. There was 17 booths occupied by local and out of town dealers. See the list of dealers below.



The Kuhlman Center parking lot was close to full on Saturday, March 5th. This was the 43rd Annual Spring EIGGS Show held here in Richmond.



Sherry is preparing to try her luck at spinning the wheel to see if she can win some pretty rocks. Dakota Jones from Richmond, waits for Sherry to spin the wheel.



The Silent Auction is one of the most popular events at the show. Visitors can bid on some really nice rock & gem items they would like to win.

Eastern Indiana Gem & Geological Society's March 4-6, 2016

by The Gad-a-bouts
Ray & Sherry Dickerson
(Photos by Ray Dickerson)

Sherry and I attended the 43rd Annual Spring Eastern Indiana Gem, Mineral, Jewelry, Fossil Show and Sale in the Kuhlman Center located at the Wayne County Fairgrounds on March 5, 2016 at 12:10 p.m.

We have been attending the Eastern Indiana Gem and Geological Society (EIGGS) Gem and Geological Gem, Mineral, Jewelry, Fossil show and sale for a very long time.

I don't recall seeing so many vehicles in the parking lot in previous visits. Inside the building it was crowded. Of course one thing that may have hindered visitors in the last two years could have been from the road construction on Salisbury Road. In this paper the last two years I had to put directions in it telling people how to get to the Wayne County Fairgrounds due to the road construction. The construction, though needed to be done, made it hard for out-of-town readers to get to the show those two or three years.

As we were walking towards the Kuhlman Center building a fellow said, "Hi Ray."

I replied, "Oh, Hi."
The fella replied, "You don't recognize me at all, Mark Lenkensdoffer, I used to work with you at GTE." (name may be spelled wrong)
I replied, "Yes you do kind of look like Mark Lenkensdoffer."

Mark replied, "Yes I do look kind of different. I said, I think your beard used to be darker."
Laughing Mark said, "Yes it was darker back then. We talked briefly about old times. It's always nice to meet friends from the past. It's those very times that makes life more interesting when we get out of the house and mingle.

We walked on and entered the building. As the number of vehicles in the parking lot indicated the show was a beehive of activity.

As usual when we attend this show, I stop to take some photos and Sherry meanders through the booths looking for pretty rocks and jewelry.

I've always been a rockhound and Sherry has too. Back in 1972 we went on vacation out west. We had acquired a piece of property from my father near the Petrified Forest area in west Arizona.. We stopped there long enough to visit an area outside the Petrified Forest that belonged to the property owners collectively. As a owner of two of the ranchero's we were allowed to go back in the high desert and collect petrified wood and other types of rock taking it with us. At that time we had a 1966 Chevelle two-door hardtop. When we left the property heading for home, our car was slightly lower in the back from the weight of the rock we picked up.

Shortly as I was taking some candid shots I



Winner of the EIGGS Scholarship they award each year was Dakota Harrison shown here with EIGGS

stopped by the Silent Auction booth. I asked a young lady who was standing behind the west end of the booth if she was tending to the spinning wheel game, there on the table. She said yes. I asked what her name was and she said it was Dakota Jones. I also asked if she was a member of EIGGS. She said yes. I then said jokingly, "I just told someone on the other

Like a good neighbor State Farm is there®

CARL SHARP
27 W. Union St. Liberty, IN
458-5574 or
800-974-5574
www.carlsharp.com



State Farm Insurance Companies Home Office Bloomington, Illinois

Your Local Full Service Butcher Shop



French's Locker LLC
106 Sycamore Street
Batesville, IN 47006
(812) 934-2902
WWW.FRENCHSLOCKER.COM
Beef, Pork, Sheep, Goat & Deer Processing
Local l y Grown 1/4, 1/2 or Whol e Beef
Avail abl e 1/2 or Whol e Pork

INLAWS ARCHERY & PRO SHOP



FUN FOR THE WHOLE FAMILY
5245 E. U.S. 40 STRAUGHN, IN 47387
765-332-2155



Sitting at their table, John and Mary Ann Morse were making "cabs" or cabachons. To the layman pretty rocks. They are from Milton and are members of EIGGS.



Evelyn and Ray Lahti from Knoxville, Tennessee have had a booth here in Richmond for the past 3 years at this show and say they do really well here.



At left Charlene Reidenbach and at right Mark Lisota, current President of the Eastern Indiana Gem and Geological Society. Two very important people.



From left to right Sherry Dickerson, John Lamont and Charlene Reidenbach. See more about these three very important people in article below.

side of the room that you don't spell eggs EIGGS!"

I left the booth to go find Sherry, I wanted her to try her luck at winning some pretty rocks.

I found her looking at some very pretty rocks, gems and fine jewelry. I asked her to go with me so I could get a photo of her and Dakota, while she played the spin game at the Silent Auction booth.

It was twenty-five cents a spin so I gave Dakota a dollar bill for 4 spins. Sherry won a prize all four times, where ever the needle stopped you won a prize. Sherry thanked Dakota and as she happily carried her bag of pretty rocks with her. I was smiling too!

Sherry went back to visiting more booths and I went to take some more photos. I stopped to talk to one of the dealers, Ray and Evelyn Lahti from Knoxville, Tennessee. They told me they had been coming to the EIGGS rock and gem show for three years. I asked them how they did here. Ray said they have done really good here.

I took a lot of photos and talked to quite a few dealers and visitors alike. I genuinely like looking at the rock lighted display boxes along the north wall. The displays are like a box with a window at the front, the rock or other display is well lighted to highlight the display. This year they had Fossil Forests of West Virginia by Earlham Geology Fall Field Trip 2015, Petrified Wood, Eastern Indiana Gem & Geological Society celebrating 50 years from 1966 to 2016 and several other displays.

I looked around the room, spying my wife who was still admiring all the pretty rocks, gems and thousands of other interesting items on display. I walked over to see if she was ready to go.

I then saw that Charlene Reidenbach had returned to the booth she and John Lamont share at the shows. I told Sherry I wanted to go see them. I've gotten to know Charlene and John real well seeing them at the different EIGGS and other rock and gem shows in Indiana. See their photo above with Sherry, also there is a photo of Charlene with the president of EIGGS in their booth. As we talked Dave Straw came to their booth, he is another EIGGS member and office holder in the club who many of you will remember from past articles I've done. Dave gave me a tour of the EIGGS building located on U.S. 40 near Centerville a few years ago.

The Eastern Indiana Gem and Geological Society's Scholarship winner this year was Dakota Harrison from Lincoln High School. She is planning to attend college at IUPUI for Forensic and Investigative Science.

The Eastern Indiana Gem and Geological also donate \$500.00 to Earlham College for their science class.

Charlene gave me a list of the dealers attending the 2016 show here in the Kuhlman Center at the Wayne County Fairgrounds this year, they were Manning Rock Shop Troy, Ohio; Lavins Gems & Jewelry Schiller Park Illinois; Canton collectibles Martinsburg W. Virginia; D'Jar Meteorites Taylor Michigan; HMD Minerals Connersville, Indiana; La-Monts Rock Pile Brookville Indiana; Haggards Morgantown, Indiana.; Lost Cove Minerals Marion North Carolina.; Blue Chip Minerals Bedford, Kentucky.; Wonders of the Earth Dayton, Ohio; Jacqueline Gross Point Woods Michigan; Pretty

Things Kent, Ohio; Blue Sled Cincinnati, Ohio; Nayab Gems Brownstown, Michigan; Rocks & Opals Knoxville, Tennessee; Multi Facet Productions Rock Creek, Ohio and Hidden within Cabs & Slabs Indianapolis Indiana.

We are truly blessed to have an organizations like The Eastern Indiana Gem and Geological Society to provide a source of learning for the young and older generation alike to learn about this earth, what was here and is still here on earth. ■

Roaming The Outdoors

CONTINUED FROM PAGE 23

MOVING WALL COMING TO VETERAN MEMORIAL PARK SEPT 22-25, 2016

The Moving Wall will be coming to Richmond. A Huey helicopter from Peru, IN will be here from Friday afternoon to Sunday afternoon. They will be taking people for rides for a fee. Robert Doubek will be the Saturday Speaker. He worked with Jan Scrugs getting the Wall approved, financed and built in D.C. The Veterans are wanting to get a combined county school band and they want to have Gold Star family ceremony also.

Right now what they need most is donations to help cover everything. They estimate that it will take between \$15,000 and \$20,000 in expenses. Please help make this happen by donating dollars. Make donations payable to "Veterans Memorial Park" Send to P.O. Box 2401, Richmond, IN 47374. ■

TREE CITY METAL SALES

• Crews Available

- ◆ Metal Sales
- ◆ Pole Barns
- ◆ Vinyl Fencing
- ◆ Garages
- ◆ Garage Doors

Steve Wagler
50 W. 650 N, Greensburg
812-663-4863 Cell 812-523-6272

Deli

NOW OPEN

- Lunch Meats
- Cheese
- Butter
- Sandwiches

Troyer's Country Store & Bakery
8 mi. North of Greensburg or 10 mi. South of Rushville on SR 3
Hrs: Monday to Friday 8-5 / Saturday 8-4
(765) 629-2604

Riggle-Waltermann

MORTUARY, INC.
32 SOUTH ELEVENTH STREET
RICHMOND, INDIANA 47374
PHONE (765) 966-7684

N.F.D.A.
I.F.D.A.
www.riggle-waltermann.com



Part 3 by Ray Dickerson

Assisted by Jim Price (Picture Above) Executive Director of Grissom Air Museum

Part three was supposed to be in an earlier issue, but I didn't have enough room for it in that issue so I held it until after the sport show issues.

As you can see below the Grissom Air Museum has been closed since the end of November and opens for the season in March. See the Hours of Operation listed here.

Hours of Operation:

March thru Memorial Day
Fridays, Saturdays 10 a.m. - 4 p.m.
Sundays Noon - 5 p.m.

Memorial Day thru Labor Day

Open 7 days a week

Labor Day thru November

Fridays, Saturdays 10 a.m. - 4 p.m.
Sundays Noon - 5 p.m.

Top Left: Inside the Grissom Air Museum building you can see inside the cockpits of the Phantom 4C and other static displays. You will spend a lot of time in the Museum once you get there. Top Right: This is a photo of the Pilots cockpit of the Phantom 4C. Middle Left: Jim Price, Executive Director of the Grissom Air Museum. If you have any questions about the Museum Jim can answer them. He has been at the Museum for a long time. Middle Right: The A-10A Thunderbolt. A tank killing Warthog that earned great distinction in the Middle East. Bottom: The F-4C Phantom II most successful and versatile fighter in Vietnam era. I have a short story about the first Phantom I saw in England in 1961 at RAF Chelveston. We heard through the grape vine a Navy jet was landing at Air Force bases in Europe for the Air Force to see if they wanted some. As luck would have it one was coming to our base. The day it was to land at Chelveston, it was a typical English day, so foggy you couldn't see the tops of buildings. We heard the noise of the jet landing, but no one could see it until it taxied off the runway. It was all white, had the landing hook on it and beautiful to behold. It didn't stay long, just the brass to see it. Then off it went disappearing into the fog.

Operational Information

Grissom Air Museum offers guided tours for groups of ten (10) or more people. Please call 574-398-1451, to schedule your group tour.

Admissions

Grissom Air Museum accept all major credit cards and debit cards
General Admission: \$6.00
Children ages 5 and under: Free
Senior's (ages 61+) and Military (past or active): \$1.00 discount

My last visit in November of 2015 I finally got the nerve enough to climb to the top of the four story tower located at the southeast corner of the static aircraft area. It was quite windy that day, which didn't

make it anymore comfortable for me. There is a good photo of the tower on the next page. I've never been afraid of heights, when I was in the Air Force I volunteered for any way of getting to fly somewhere.

In Part 1 of this 3 part series on Grissom Air Museum I had photos of the WWII reciprocating engine planes. In Part 2 I had photos of the early jet era and in Part 3, this one, I have photos of Vietnam era jets plus a couple photos inside the Museum. In an upcoming issue I will put in the aerial photos of the aircraft here at Grissom Air Museum.

If you haven't visited Grissom Air Museum just north of Kokomo, Indiana off US 31 I know you will enjoy it as much as I do. You can check it out online at www.grissomairmuseum.com .

BLUE RIVER ARMS GUNS, AMMO BAIT & TACKLE OPEN
Hrs: Mon-Fri 10am-5pm, Sat 8am-?, Closed Sun
Pelican Canoes, Fishing & Pedal Boats
Hunting Supplies • Fishing Pole & Tackle
Trapping Supplies • Live Bait (Seasonal)
DNR Deer & Turkey Check Station • MRE Meals
Tannerite Exploding Targets • Air Soft Rifles
Crossbows • Handguns • Shotguns • Rifles
Muzzleloaders • Ultra-Advantage Dog Food & More
2596 W. Old Franklin Road • Shelbyville, IN 46176
317-392-2627 or 317-771-5600
www.blueriverarms.com

Always Custom Processing!
Over 40 Years of Experience
NOW IN 2 LOCATIONS TO SERVE YOU BETTER
DEER PROCESSING
Processing • (812) 866-4710
4251 S. 850 West
Pantry • (812) 866-MEAT (6328)
367 W. LaGrange Rd.
Both in Hanover
www.patespantry.com
VIP CLUB Text PATES to 77948

THE GUN DEN
Buy - Sell - Trade
337 Roosevelt Dr. Shelbyville, IN 46176
(317) 398-3852
FOR ALL YOUR OUTDOOR & HUNTING NEEDS
CHECK OUT OUR WEBSITE AT
www.thegundenonline.com
A Large Selection of Kimbers in Stock
ALL LONG GUNS ON SALE
We do special orders and layaways



The photos above are a few of the aircraft at Grissom that was heavily used in Vietnam. Top Left: The F105D Thunder Chief a hard hitting, supersonic "Thud" used extensively in Vietnam. Top Right: F-14B Tomcat, Navy's famous "Top Gun" Fighter Bomber. The Tomcat was made more famous when Tom Cruise with his call sign "Maverick" flew the swing wing fighter. Bottom Left: UH-1H Iroquois. Multi-role "Huey" inaugurated new "air mobility" Warfare in Vietnam. This aircraft was used for everything in the movies too, in Star Trek 5 a Huey was used to load huge plastic plates into a space ship so it could haul "hump back" whales to earth. Bottom Right: A Navy Sky Hawk used aboard aircraft carriers in Vietnam, also used to train pilots to land on aircraft carriers. Below: Observation Tower I climbed to get a birds eye view of the Grissom Air Museum. I was probably at the top for a very long time fascinated by being above it all. I took a lot of photos.



An aerial view of many of the planes at Grissom Air Museum. I don't have a wide angle lens, if I did I could have gotten more planes, but it is still a pretty view. When I was in high school I had a collection of plastic models of all aircraft.

EBBING
AUTO PARTS, INC.

Quality Parts with "Experience"
www.ebbingautoparts.com

8 a.m. - 5 p.m. Monday - Friday (E.S.T.)
 6090 West U.S. Highway 50
 North Vernon, IN 47265

800-678-3105
 812-346-1323
 Fax: 812-346-8259
sales@ebbingautoparts.com

USED PARTS
 It's Called
 Recycling

MEMBER
 AUTOMOTIVE
 RECYCLERS
 ASSOCIATION
 ESTABLISHED 1932

Heritage Goodhew Enterprises, Inc.

**HERITAGE
 GOODHEW
 IRON HANGERS**

STANDING SEAM METAL ROOFING
 New Installation & Metal Roof Repair

765-857-2623

www.heritagegoodhew.com

JoAnn's Cafe

723 S. 5th Street
 Turn right off "G" St. Bridge
 Richmond, IN 47374
 765-935-2528

Dine In
 or
 Carry Out

"Buy 1 Every Day Special"
 "Get 2nd One at 1/2 Price"
 1-4 pm Mon, Wed & Thurs.

Owners: James & Michelle Miller

Mon, Wed, Thur & Friday 6:00 am to 6:00 pm
 Tuesday & Saturday 6:00 am to 2:00 pm

**Daily Homemade Specials
 Breakfast & Lunch "Served All Day"**

BRING THIS COUPON

2015 Hancock County Birds

by Frank Wyant

In the year 2004, the DNR released 14 turkeys in southern Hancock County. Although Bud Denneman and I had been involved in the NWTf since 1988, this was the first time we had ever been invited to help release birds in the state. We met Jerry Jackson, then Conservation Officer for Hancock County, John Maxwell from the DNR, and one other DNR person at Jerry's house along Brandywine Creek and released 5 gobblers and 9 hen turkeys. Over the years I have heard stories about sightings of one or two birds in the county, but I have never actually seen one myself until last year.

I live trap in my back yard. It's kind of weedy and I get a lot of opossums, raccoons and skunks and a few cats. If the cats are friendly or have a collar, I usually let them go. The others ! take down to Blue River by Morristown and release. One day last year, I saw a hen out in the field by the release site and was amazed. But there is a farm house close by and I thought it might be a pen raised bird that just got out and was wandering around. But I always hoped it was a wild one. A few weeks before spring turkey season, I took an opossum down to the area and just happened to look out in the adjoining corn field and thought I saw a deer, way down at the far end. It must have been a quarter mile or more, so I got out my binoculars and saw it was a tom in full strut. It's been 11 years and this is my first sighting in Hancock County, and only 3 or 4 miles from my house. I was giddy with excitement. I called Bud immediately and told him. He was very happy to hear that our efforts were finally paying off.

I went back a day or two later and walked out to where I saw the bird and found a strut zone on a high spot in the field. He had a real good advantage up on the point and could see the whole field from his spot. Since I had already harvested my bird on the 27th of April, I took a couple of decoys and my pop-up blind and set upon property that I had permission to hunt, to try and call him in for some pictures, but he wouldn't have any of that. He just stayed in his safe area and gobbled his head off, telling the girls to come to him. I went back 2 or 3 different times, trying to get him to come over to my side of the field, but he would have nothing to do with that. I tried to get permission to go on to the property and get closer, but it was owned by a family who lived in Carmel, Indiana and they didn't want anyone to trespass, even though I was only going to take pictures. So I'm now in the process of getting permission from 3 other farmers on surrounding farms to try a different approach. Hopefully by next turkey season, ! will be able to hunt or at least take some pictures of the wary old bird.

SPRING 2015

We started spring gobbler season as always in the HOOSIER NATIONAL FOREST just south of Nashville, Ind. Bud D., Rick F., and I always hunt public ground the first three days of the season because it's very familiar to us as we used to grouse hunt the area and we've gone over every

inch of this particular spot. We've been over this area forwards and backwards, plus there's a bunch of mushrooms in a couple secret places we found. We split up and call for a few hours and if no turkeys appear we hunt mushrooms a little and then move on to another area and start all over again. This year wasn't much different than years past. I heard one sound off from the roost and when he hit the ground he shut up. I assume he was in with some hens. So around 11:00 I had moved a couple times and was fairly sure it was going to be a birdless day when a Jake came in fast and quiet. He never stopped or acted like he was coming to my calls, just passing through and in a hurry to get somewhere, and at 70 or 75 yards out I didn't have any kind of a shot, so at least I saw one. We had all agreed to meet back at the truck at 12:00. Rick and I were there within 5 minutes of each other. Bud on the other hand is always the last one to show up; but then again he's old and getting feeble in his waning years. This year was no exception. He has had a few medical issues and so we overlook a little slower pace and a tendency to take a few more power naps in the woods. Although it is some of the best sleep you will ever get; birds chirping, a slight breeze and the sun warming your back, on a nice thick bed of leaves. This season we noticed he has lost a little of his get-up-and-go, but he is closing in on 75 years old, so we have to give him a little bit of a break. Where he hunts is pretty far back an old logging road and it takes quite a while, even on a good day. Usually it will take him around 45 minutes to get out but this year its closer to an hour and a half, so it was around 1:30 before he emerged from the wilderness. As we were packing in we compared notes and sightings. Rick had heard three different toms and Bud had heard two. I hadn't heard squat, but did see the one Jake.

The next day Bud and I went to Yellowwood.:(Rick had to work) We had a little better luck, after we left the truck and before we split up we heard one gobbler off to our left, and fairly close but we went ahead and split up knowing it would be there when we got back. Besides it shut up after fly down time. Around 9 a.m. I had been calling for some time when I saw movement and there was a big tom on a ridge top about 2 fingers over from me. He was just walking along and scratching, and when I would call, he just looked up and kept going, like he wasn't interested at all. Very strange, I thought, even if he was a subordinate bird, he would come over just for a look and see what was up. That was it for me; we met up at the truck around 12:30 and called it a day.

Friday the 24th we all went back to Hoosier National Forest again; Bud, Rick, and me. As I was working my way out to the end of my ridge Bud texted me saying he heard a bird gobble on the end of my ridge. I hadn't heard anything, and when I got all the way out there and got set-up, I never heard a peep. The sun came up and there was a slight breeze but nothing going on except for a couple squirrels chasing each other around me and my set-up. Around 8.30 I thought I heard a faint cluck directly behind me, but it wasn't clear and I couldn't be sure so I froze and waited for another sound or movement. All was quiet and I didn't hear any kind of leaf movement or anything, but at 11:30 I got up and decided to start looking for mushrooms before heading out. I found some fresh scratching in the main trail behind my position about 15 to 20 feet back, so I guess a bird had

come in behind me and caught movement or saw something he didn't like, and left the area without telling me he was there.

I got out to the truck around 12:05 and Rick came out at 12:10. We both were void of mushrooms, and Rick said he had heard 3 birds that morning, but couldn't get them to co-operate. Bud finally comes lumbering out about 1:30 after Rick had decided to go look for him or 'his body, whichever he came upon first. Rick had Bud's gun over his shoulder and Bud had two walking sticks, saying if one worked well, then two was double helpful. He also didn't have any mushrooms. We decided to not hunt the weekend, mainly because it was opening weekend and a lot of first timers are out in full Rambo mode and eager to shoot something. Although we had run into a couple of mushroom hunters on Friday and they had only found 5 or 6 and said they had a real good spot and would normally have a sackful by now. Besides Bud and I are retired and need a little more rest than regular folks. This getting up at 3:30 and driving for a couple hours each day can wear on a couple old guys.

Monday had Bud and me going back to Yellowwood again. We have some friends who live in Brown County and just happen to have their back yard butt up against a portion of Yellowwood. So we can park the vehicle in their driveway and walk out the back of their yard into the forest. It also helps if they give us a turkey report during the off season.

They had said at one time during the early spring they had about 14 or 15 turkeys in their front yard, I suggested we sit on their front porch and have the Missus bring us a cup of hot coffee every once in a while and when the birds appear we can bust one, and never have to worry about getting our boots muddy, but that didn't go over to well. So we get our stuff together and head out into the woods just a little before light, and only went about 100 yards and heard a gobble, he gobbled a couple times and got silent, probably got hens with him, so we went ahead and split up to go to our respective areas.

I went down into the bottom and up the other side to my favorite spot, and where I saw the Big Tom on Thursday. By 9:30 I had eaten my granola bar and my entire trail mix and was chewing a stick of gum and thinking about maybe trying a couple of the wild onions there in front of me. No gobbles, no noise, nothing. I would even put up with some squirrel activity, but nothing. Finally after calling some more to silence, I texted Bud about 10:40 and said I was going back down in the bottom to look for mushrooms and would meet him at the truck around 12:00. So down I go, looking and shuffling around, and finally find one little mushroom in a bunch all by its self. It seemed strange to only find one, but that's all I found. Right at 11:00 I heard a shot, sounding like it came from Bud's direction, I waited a few minutes and texted him "Is there any chance that that noise I heard was coming from you" and he answered that it was a good possibility. So I went back to mushroom hunting and worked my way out to the truck and our friends front porch.

Dean and his dog Rodney were fooling around in the yard and garden, so when they saw me, they decided it was break time. As we sat and talked and told lies to each other, his wife brought out a couple cups of coffee, which was right friendly of her. Now I got to tell you about Rodney, he is half

LAUREL HOTEL RESTAURANT

200 E. PEARL ST. LOCATED 1 BLOCK OFF SR 121 IN THE QUAIN HISTORICAL TOWN OF LAUREL, IN

- PAN FRIED CHICKEN
- CHAR-BROILED STEAKS
- SEAFOOD & Much More
- Seafood or Country Buffet, **Fri. - Sat. 4 - 9 P.M.**
- Full Menu, **Sunday 11 A.M. - 8 P.M.**

MENUS AVAILABLE, ALSO CHILDRENS MENU
FAMILY DINING — LARGE BANQUET ROOM
RESERVATIONS WELCOME 765-698-2912

Closed MON-WED / THU 11am-8pm / FRI & SAT 11am-10pm / SUN 11am-8pm
LESS THAN 10 MINUTES FROM METAMORA

MIGHTY MUFFLER BRAKES • SHOCKS • TIRES

Complete Automotive
Repair

"No Muff . . . Too Tuff!"

1440 N.W. 5th St., Richmond, IN
765-966-6833

TOLLIVERS

Hunting & Fishing Supplies



Directions: From Salem: go 135 N 12 mi., turn east bottom of Milport Knobs, go 3/10 mile. From Brownstown: go 135 S. approx. 10 mi., then same as above.

(812) 358-4867 or 1-800-238-0358

NISSAN
MARINE

- Guns • Ammo
- Camo Clothing
- Live Bait • Parker Bows



VISA MasterCard

See Us For All Your Archery Needs

chocolate lab and half bull mastiff and half Tennessee walker, if you didn't know him, you would truly believe he would bite your arm off and eat it right in front of you, but to be honest he is a sweetheart and would rather lick you to death than hurt you in any way. He just looks like a different color of (CUJO). So Dean and I sat and talked for awhile and I told him we were supposed to be out at 12:00 and since it was 12:30 and no Bud \ was a little concerned: 12:45 no Bud, Finally at 12:50 I told Dean I was going to look for the old geezer. I headed back into the woods and just as I got to the edge of the finger Bud went out, here he came. He usually has a hard time climbing out and up from the bottom but with a bird over his shoulder it could give him problems. He had a Jake over his shoulder and was dragging his butt along behind him. He said he had a 2 yr old bird come in but saw something he didn't like and took off ,and the four Jakes were following the bigger bird but when they came in and saw he was gone they got real nervous and that's when Bud shot one of them. So we are standing there telling each other our stones when a bird gobbled down in the bottom, directly where Bud had just come from.! said "well that figures, here I am with no gun and no face mask or gloves and there's one following you out of the woods." Bud said "let's call it in for you", but I didn't have any of my stuff. He said "here use my gun and just sit quiet". So ! grabbed a couple May apple leaves and stuck them in my hat to break up my snowy white cheeks and another one for my hand and got down against a big oak. Bud cranks a round of yelps and soft purrs and he gobbled again only a lot closer this time, maybe 60 yards out. Bud says "I see them, there are two of them, can you see them" I said "no not yet", so Bud did a little cackle and purr and the first one came into view at 20 yards, and as I eased back on the trigger he stepped forward enough that I could see his head and neck area. I pulled the trigger and saw two birds fly off Sike rockets. My heart stopped. How could I have missed? My eyes were as big as dinner plates. I asked Bud "How in the world could I miss at this range? It's it farther than it looks, how can it be that! missed" Bud said "I think you got him"/ But I saw two birds fly away", Bud says "there were three coming in, but I saw one drop when you shot" so I get up and go over and there he was. a two yr old bird with % inch spurs and a 11 inch beard. My heart started beating again and I might have wet myself just a little. This was a first for me, in 26 years of turkey hunting,! got a bird without a face mask or gloves and with someone else's gun. UNBELIEVABLE,

We got back to the truck and took pictures and retold the story for Dean and Rodney, who just sniffed but didn't try to eat them. When we checked them in Buds was 14 pounds and about a 4 inch beard with bumps for spurs, mine was 20 pounds with a 11 inch beard and % inch spurs. What an experience, I would never have guessed that would work. I guess when the time is right, it's right. As of this writing Rick has yet to get a bird or any mushrooms.

Editor's Note: I got this article from my good friend Frank Wyant and his hunting buddy Bud Denneman. I held it until I had room for the entire article, which is a long one, but it is plumb full of good turkey hunting information. Thanks Frank for sending me this article. It fits perfect in my April paper. Ray

GAD'S CORNER

Send your game photo online to raythegadabout@gmail.com or Photo to The Gad-a-bout, 105 E. S. St., Centerville, IN 47330



Ray this is my 2015 Pope & Young buck. This is my largest buck yet. He's a 12 point with double brow times. He had a live weight of over 250 lb. and field dressed 210 lb. He age's at 5.5 yr. old. My best bow kill of my life. Thank's to Hoyt and Easton for incredible product's. (InLaws Archery & Pro Shop Photo, Straughn, IN)



Wyatt Case with his Wyoming Pronghorn Antelope he took 10-6-15. (Red Barn Bait & Guns Photo, Salem, IN)



Darin Sweeney took this 8 point, 145 lb. buck on 11-28-2015. (Red Barn Bait & Guns Photo, Salem, IN)



9th Annual

Smokin' on the Water BBQ Festival By The Lake

April 29 thru May 1, 2016

3801 W. Old Dunlapville Rd. Liberty, IN 47353
(Free Parking and Admission)



Hours:
Friday Noon - 9 p.m. • Saturday 9 a.m. - 9 p.m. • Sunday 9:00 a.m. - 5:00 p.m.

The Indiana Smokin' on the Water BBQ Festival by the Lake is sponsored by the Liberty Lions Club, all proceeds go to Community Service projects of the Liberty Lions Club.

Activities include a Craft Show, a KCBS BBQ and Open BBQ cook off of Chicken, Pork Ribs, Pork and Beef Brisket, a Kids Que BBQ contest, Award winning Barbeque (Ribs, Chicken, etc) & other great eats, Craft Fair, Home Show, Music, Food, & Fun, Antique Tractor & Farm Equipment Exhibits, Handmade Furniture and Instruments, RVs, Mobility Carts, Golf Carts, Mowers, and More, Home Improvement Products, Handmade Jewelry, Healthcare Products & Services, Live Bluegrass Music (Saturday Evening), Antique and Classic Car & Truck Show (Sunday), BBQ Contest (Sunday afternoon) and all happening in the Treaty Line Museum.

2 Hoosier BBQ Cup Events

These two contests (Saturday & Sunday) are 2 of the first stops on the points trail for the 2016 Hoosier BBQ Trail



Saturday's BBQ Contest is a KCBS Sanctioned Event - \$5,000* in prize money!

Sunday's BBQ Contest is a KCBS Sanctioned Event - \$5,000* in prize money!

Sunday's BBQ Contest is also a Beak to Beak Event!

Both Contests are State Championship Events!

*(The Prize Money is subject to increase for each day's BBQ contest, based on participation.)

WELLS VARIETY STORE

10th & Eastern, Connersville, Ind.

1-765-825-8586 ~ 1-800-398-5062

Carhartt FOR MEN, WOMEN & KIDS

Hard at work since 1889

MUCK, ROCKY, LACROSSE, DURANGO & M^C RAE BOOTS



WRANGLER JEANS

Monday - Friday 8:00 a.m. - 5:00 p.m.

Saturday 8:00 a.m. - 4:00 p.m. / Closed Sunday

If we don't have it, you don't need it!!!



Kailee Akers took this 8 point buck on 11-25-2015. (Red Barn Bait & Guns Photo, Salem, IN)



Yancey Edlin took this 5 point buck on 11-15-2015. (Red Barn Bait & Guns Photo, Salem, IN)

BROOKVILLE LAKE FISHING DEPTH MAP (UPDATED 2015)

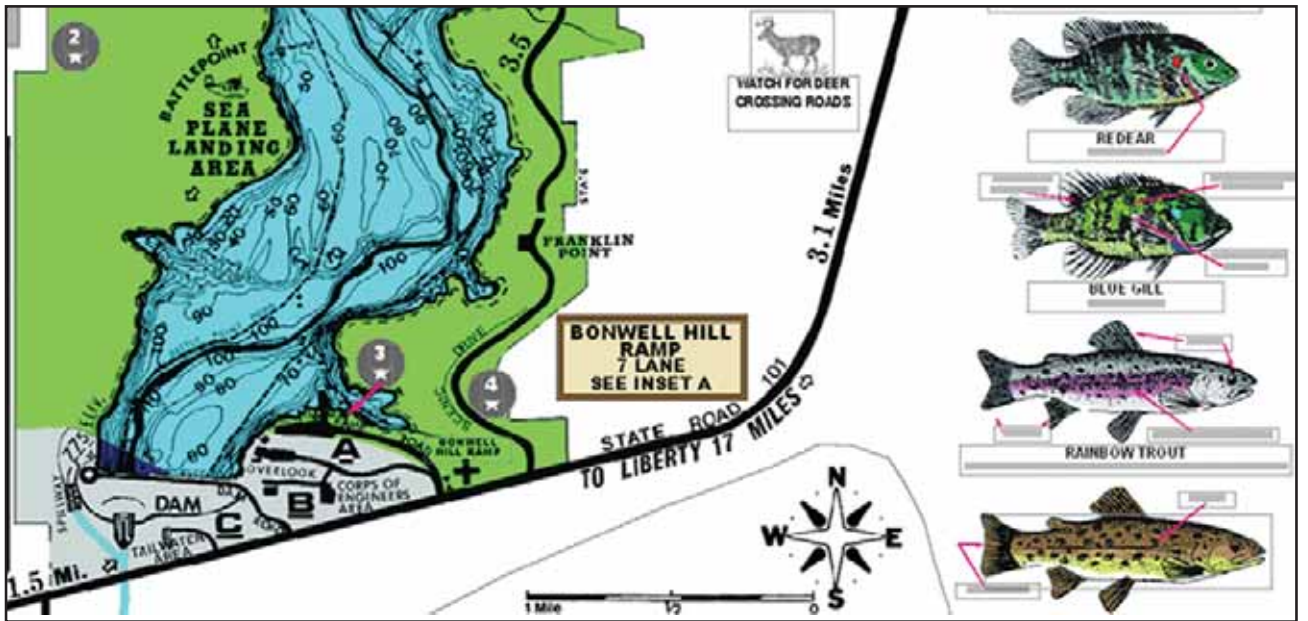

PURCHASE YOUR 21 1/4" X 33" BROOKVILLE LAKE FISHING DEPTH MAP (See Below For Details)

(Note: The Map on the cover is not this map, see page 7 for that map)

The Brookville Lake Map is printed on two sides in Full Color. See Example at Left, this is a sample portion of the Front Side or Bottom half of Map, this is the Dam area with drawings of the fish in Brookville Lake with identifying markings and other details. There are 14 fish on the Front of Map. The Bottom Half of the map is from Brookville, north to just above Egypt Hollow and Fairfield Ramps. The Top Half of the map is from just below Hanna Creek Ramp north to Brownsville, IN. There is an Inset of the portion of the Brookville Lake area from just above Brownsville to Yankeetown Bridge (The Brookville Lake ends just below Treaty Line Ramp and The East Fork of the Whitewater River begins there and north to Yankeetown Bridge.)

Brookville Lake Area

Illustrated: Depths, Contour lines, Underwater structure (1974), Ramps & Parking areas, Marinas, Buoy areas, State Campgrounds, Beaches, Picnic areas, Pay telephones, Playgrounds, Shelters, Game courts, Rifle, Pistol & Archery ranges, Hunting areas, Handicapped fishing piers, Restrooms, Showers, etc. (See Bottom Half for Legend of Underwater structures, Facilities & other map symbols or keys. Information on "How to properly measure your fish and reference to recording your record fish." Colored Drawings of

the fish in Brookville Lake and identification markings for each fish.

Whitewater State Park Area

Illustrated: Trails, Campground, Boat Rental, Cabins, Saddle Barn, Shelters, Picnic areas, Beach, Fishing piers, Ramps, Nature Preserve, Whitewater Lake and access to Brookville Lake

HUNTING AREAS

Illustrated: See Hunting information on Top Half, in lower left hand corner. The Hunting areas are marked on the map with a Star and number (check points). More information is adjacent to check point on acreage and game.

COLOR CODED AREAS

Illustrated: Medium Blue, Unlimited Speed Zone; Light Blue, Idle Zone - No Wake No Wash; Dark Blue, Restricted Area - No Boats Allowed; Green, Indiana Dept. of Natural Resources Property; Light Brown, Waterfowl Resting Area (IDNR Property) Gray, U.S. Corps. of Engineers Area

Light Cyan Blue, Tan, Yellow & Gray - Information Boxes

To Order The Brookville Lake Depth Map by Mail

Send \$2.00 for 1 map + \$2.00 mailing cost = \$4.00
 Send \$4.00 for 2 maps + \$2.00 mailing cost = \$6.00
 Send \$6.00 for 3 maps + \$2.25 mailing cost = \$8.25
 Send \$8.00 for 4 maps + 2.35 mailing cost = \$10.35
 Send To: The Gad-a-bout, 105 E. South. St., Centerville, IN 47330 (Make Check or M.O. To: The Gad-a-bout)

COLOR RATES: 1 SPOT COLOR (ALL SIZES) \$10 • FULL COLOR 6-11 COL IN \$15 / 12-25 COL IN \$25 / 26-49 COL IN \$35 / 50-94.5 COL IN \$50

THE ADVERTISING RATES BELOW ARE FOR BLACK & WHITE ADS ONLY - FOR COLOR ADS ADD ABOVE RATE

THE GAD-A-BOUT ADVERTISING RATES

PLEASE NOTE: EACH DOLLAR AMOUNT BELOW IS PER INSERTION

FULL PAGE 15.75" X 10.37"	1/2 PAGE ALT. SIZES 7.82" X 10.37" 12" X 6.88" 15.75" X 5.13"	1/3 PAGE ALT. SIZES 5.25" X 10.37" 7.82" X 6.88" 15.75" X 3.37"	1/4 PAGE ALT. SIZES 4" X 10.37" 6" X 6.88" 7.82" X 5.13"	1/8 PAGE ALT. SIZES 3" X 6.88 4" X 5.13 6" X 3.37	1/10 PAGE ALT. SIZES 3" X 5.13 4.5" X 3.37	4 COL. INCH ONE SIZE 4" X 3.37"	1/15 PAGE MONOPOLY CARD SIZE ONE SIZE 3" X 3.37"
94.5 COL. IN.	48 COL. IN.	32 COL. IN.	24 COL. IN.	12 COL. IN.	9 COL. IN.	8 COL. IN.	6 COL. IN.
1 TIME	1 TIME	1 TIME	1 TIME	1 TIME	1 TIME	1 TIME	1 TIME
\$7.50 PCI	\$7.50 PCI	\$7.50 PCI	\$7.50 PCI	\$7.50 PCI	\$7.50 PCI	\$7.50 PCI	\$7.50 PCI
\$708.75	\$360.00	\$240.00	\$180.00	\$90.00	\$67.50	\$60.00	\$45.00
2-11 TIMES	2-11 TIMES	2-11 TIMES	2-11 TIMES	2-11 TIMES	2-11 TIMES	2-11 TIMES	2-11 TIMES
\$6.50 PCI	\$6.50 PCI	\$6.50 PCI	\$6.50 PCI	\$6.50 PCI	\$6.50 PCI	\$6.50 PCI	\$6.50 PCI
\$614.25	\$312.00	\$208.00	\$156.00	\$78.00	\$58.50	\$52.00	\$39.00
12 TIMES	12 TIMES	12 TIMES	12 TIMES	12 TIMES	12 TIMES	12 TIMES	12 TIMES
\$5.50 PCI	\$5.50 PCI	\$5.50 PCI	\$5.50 PCI	\$5.50 PCI	\$5.50 PCI	\$5.50 PCI	\$5.50 PCI
\$519.75	\$264.00	\$176.00	\$132.00	\$66.00	\$49.50	\$44.00	\$33.00

ADVERTISERS INFORMATION

(PLEASE PRINT LEGIBLY OR TYPE)

SALESPERSON: _____ DATE: _____

BUSINESS NAME: _____

OWNER NAME (S) _____ MGR. OR OTHER _____

STREET OR P.O. BOX: _____

CITY _____ STATE _____ ZIP CODE _____

PHONE: _____ FAX: _____

CELL PHONE: _____ OTHER: _____

E-MAIL: _____ WEB SITE: _____

Ad Size _____ Rate: \$ _____ Monthly Cost: \$ _____

CIRCLE METHOD OF PAYMENT - CHECK #: _____ CASH: _____

PLACE AD IN JAN FEB MAR APR MAY JUN JUL AUG SEP OCT NOV DEC

(CIRCLE APPROPRIATE MONTH (S) THE ADVERTMENT WILL BE IN)

Customer Authorization Signature: _____ DATE: _____

ADVERTISING NOT ACCEPTED FOR: ALCOHOL, TOBACCO OR GAMBLING

**6330 So. C.R. 575 E
Selma, IN 47383
Ph. (765) 286-5049**

**2830 E. Memorial
Muncie, IN 47302
Ph. (765) 287-8587**

Open 7 Days

Red Barn Bait Shop

Hunting, Fishing, Camping,
Guns, Ammo & Accessories
Buy - Sell - Trade
Open Monday thru Saturday - Closed Sunday
Phone: (812) 883-6483
For all your hunting & camping needs stop by the Red Barn
3 1/2 Miles North of Salem on SR 135

Plan your Indiana adventures at

www.INDIANAOUTFITTERS.com

INDIANA'S ONLINE OUTDOOR RECREATION GUIDE

Link up to us at www.INDIANAOUTFITTERS.com

Find all the info you need
with this **FREE**
Indiana Trip Planning Website!



Where do you want to go
this weekend?

Visit

www.INDIANAOUTFITTERS.com



FREE! Indiana Cabin Rentals Guide
www.IndianaCabinRentals.com



Now finding cabin rentals is easy.

Use a clickable map of the state to find a rental cabin!



Looking for lodging with a hot tub?

Want a place by the water?

Find traditional log cabins, historic cabins, floating cabins, camping cabins, and unique rental homes throughout Indiana.



Why settle for a stuffy hotel room when there are options like this?

Rent your own private cabin!



Want a secluded cabin with peace & quiet?

Want a cabin near the heart of the action?



Need a pet-friendly cabin?

Want a basic camping cabin without all the frills?

www.IndianaCabinRentals.com

Find specials, pictures & links to cabin rentals around Indiana



10% OFF the ENTIRE FIELDS OUTDOOR ADVENTURES STORE.

(valid for all items not specifically sale priced)

Plus an additional 2% off for CASH

126 South Perkins St.
Rushville, Indiana 46173
765.932.3964
www.fieldsoutdooradventures.com

Store Hours: Tues-Fri — 10 am to 6 pm.
Sat — 10 am to 5 pm. Sun — 1pm to 5pm

All items in stock at time of ad. Pricing valid while supplies last. Sorry, no rain checks or special orders. Not responsible for typo errors. Case quantities available on some ammunition. Sale prices not valid for gun trade ins.



See our new selection of Browning, CZ, Dan Wesson, Ruger, Smith and Wesson, Remington and Kimber



Powder	Sale Price	Powder	Sale Price	Powder	Sale Price
TiteGroup	\$15.99	XBR 8208	\$19.99	IMR 4227	\$19.99
H4831	\$19.99	W296	\$17.99	H380	\$16.99
H4895	\$19.99	IMR 4320	\$17.99	CFE223	\$19.99
BLC(2)	\$16.99	IMR Hi-Skor 800-X	\$16.99	IMR 4064	\$19.99
WSH	\$17.99	IMR Hi-Skor 700-X	\$15.99	WC760	\$17.99

Select ALLIANT powders in stock now



Get those late season coyotes with the new Foxpro Deadbone. Regularly \$149.99. Now \$99.99

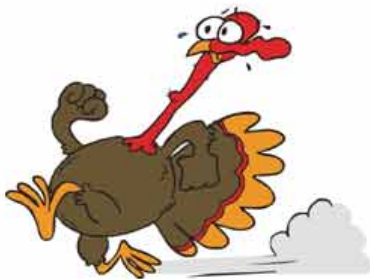

All Turkey Decoys and Calls

10% OFF

Turkey Shotshells TOO

All coyote accessories
15% OFF



Champion 135 Count Clay Pigeons
Regularly — \$13.99
Sale — \$11.99



Coyote Reaper — Green light w/ 100 rds Fiocchi .223 FMJ
\$199.99



Rifle (Prices per 200 Round case unless otherwise noted)					Handgun (Prices per 1000 Round case unless otherwise noted)			
Manufacturer	Caliber/Bullet	Sale Price	Manufacturer	Caliber/Bullet	Sale Price	Manufacturer	Caliber/Bullet	Sale Price
Barnes	.300 Blackout 110GR TSX	\$200.00	Fiocchi	.243 Win 70GR PSP	\$150.00	Aguila	.40S&W 180GR FMJ	\$250.00
Barnes	.243 Win TSX 80GR	\$250.00	Fiocchi	.223 Rem 55GR FMJ 1000RDS	\$330.00	Aguila	.32 Auto 71GR FMJ	\$250.00
CCI	.17HMR A17	\$49.99	Fiocchi	.223 Rem 55GR PSP	\$85.00	CCI	.40S&W 180GR Speer Gold Dot 200RD	\$150.00
Federal	.270 Win 130GR or 150GR PSP	\$150.00	Hornady	.357 Rem Mag 140GR LeveRevolution	\$140.00	Hornady	9mm 115GR XTP or Critical Defense 250RD	\$140.00
Federal	30/30 Win 150GR PSP	\$150.00	Hornady	.243 Win 58 GR V-Max Superformance	\$200.00	Hornady	.45ACP 185GR Zombie Max 200RD	\$160.00
Federal	.243 Win 100GR PSP	\$150.00	Remington	.243 Win 80 GR Premier Copper Solid	\$200.00	PMC	.357 Rem Mag 158Gr SJSP 500RDS	\$200.00
Federal	.30-06 Spfld180GR PSP	\$150.00	Remington	.308 Win CORE LOKT 150GR PSP	\$150.00	Remington	.40S&W 180GR FMJ UMC	\$250.00
Federal	.308 Win 168GR GOLD MEDAL MATCH	\$250.00	Steadfast	.300 AAC Blackout 125GR HP	\$150.00	Ultramax	.380ACP 95GR FMJ	\$260.00
Fiocchi	.308 Win 150GR FMJ	\$120.00	Winchester	.243 Win 80 GR JSP	\$150.00	Ultramax	.45ACP 230GR FMJ	\$350.00